

Price List

Effective August 01, 2005



**Sunguard Shade Structures
CORPORATION**

www.floridasunshade.com
sales@sunguard.net
1.800.319.1010

Premier Manufacturer of Shade Structures

Promoting Sun Safety & Cool Comfort

Contact & Contents

Address	4487 B Ashton Rd • Sarasota FL 32433
Toll Free	1.800.319.1010
Phone	941.925.3000
Fax	941.925.3001
Web Site	www.floridasunshade.com
email	sales@sunguard.net



I personally received and opened the boxes to the shade structures and personally installed one. I just wanted to thank you personally for your efforts in getting them to me on time. I've attached a picture of the one that I assembled, it looks great and was very easy to do.

Thank You



Florida State Contract

Contract	650-001-04-1
Toll Free	1.800.319.1010
Phone	941.925.3000
Fax	941.925.3001
Web Site	www.floridasunshade.com
email	sales@sunguard.net

	Page	Type
Contact Information	2	Information
Contents	2	Information
Why Sunguard?	3	Information
Florida State Contract	4	Information
Sun Safety	5	Information
Rectangles	8	Standard
Squares	9	Standard
Triangles	10	Standard
Hexagons	11	Standard
Octagons	12	Standard
Star-Octagons	12	Standard
BreezeBrellas	13	Umbrellas
Play Towers	14	Playground Towers
3-Row Bleacher Covers	16	Bleachers
5-Row Bleacher Covers	17	Bleachers
10-Row Bleacher Covers	18	Bleachers
T-Styles	19	Dugouts & Benches
Side Panels	20	Protection
Shade Park: Double Row	22	Cantilevers
Shade Park: Single Row	23	Cantilevers
Shadow Wing	24	Cantilevers
Super Contemporary	25	Cantilevers
Contemporary	25	Cantilevers
Custom Designs	28	Custom Units
Heating Systems	30	Accessories
Lighting Systems	30	Accessories
Logos	30	Accessories
Misting Systems	30	Accessories
Post Pads	30	Accessories
Replacement Covers	30	Accessories
Surface Mount Plates	30	Accessories
Direct Imbedment	32	Installation
Sleeve Imbedment	32	Installation
Surface (existing pad)	32	Installation
Surface (new footings)	32	Installation
Fabrics	34	Information
Frames	35	Information
Custom Applications	36	Information
General Notes	36	Information
How To Order	36	Information
Sealed Drawings	36	Information
Warranty	36	Information

Best Quality Steel

Sunguard Shade Structures, Corp., exclusively uses Allied Steel products; cold-rolled, galvanized tubular steel with a triple layer of protection. Allied products outperform most steels in tensile strength and long-term corrosion resistance. In saltwater spray and other weathering tests, Allied Steel outperforms the competition.

The Welds

Sunguard uses a special galvanized welding wire and then triple treats each weld for extra corrosion protection.

Best Quality Fabric

Sunguard Shade Cloth fabric is known for its' great strength, vibrant colors and durability. Our covers are made from *high-density polyethylene with ultraviolet additives, using mono filament and tape construction.* Sunguard covers are *rachel knitted* which ensures fabric stability and prevents the fabric from fraying, even when cut. This special knitting also ensures a consistent shade pattern.

Technical specs:

- Fabric Burst Strength: 260 KPA
- Tear Strength: 100 KG (warp)
- 210 KG (weft)

The Corners

Sunguard *triple reinforces all connecting points.* Each connecting point has nylon webbing sewn in the interior to further reinforce the corner. In addition, the corners are designed to conceal the tensioning cable to give clean, smooth lines.

The Thread

Sunguard uses a Teflon (PTFE) thread from the W. L. Gore Company, which will not deteriorate in the sun. The thread carries a lifetime guarantee and will not rot due to ultraviolet exposure or other environmental causes.

The Warranty

Sunguard Shade Structures, Corp., has the best warranty in the industry. *We warranty all steel framework for 20 years and all fabric covers for 10 years.* For further information, please see our Certificate of Warranty. *This is a non-prorated warranty.*

Fire Safety

Sunguard fabrics pass the E-84 fire rating test as well as the NFPA-701 and are rated a Class 1 Material.

The Cable

Sunguard uses a special galvanized cable that is UV stabilized to tension the fabric perimeter. This ensures long-term durability for the cable and the fabric.

Ultra-Violet Protection

Sunguard is the only shade company to have its cloth *tested by an independent laboratory* to verify and certify that its cloth blocks 90% or more of the cancer causing UV radiation. All colors that pass this stringent test are indicated on our brochures.

Engineering

Sunguards are designed to meet the toughest building codes in the world! *Sunguards are routinely engineered to meet 120 mph wind loads!* They are also designed from 140 mph to 170 mph wind-borne debris regions as specified by the American Society of Civil Engineers Standard (ASCE 7-02).



Shade Structures

Annual State Contract *Frequently Asked Questions*

Contract #650-001-04-1

What products are offered on the state contract?

- Our Standard Units
 - Rectangles
 - Squares
 - Triangles
 - Hexagons
 - Octagons
 - Star-Octagons
 - Safe Fun in the Sun Shade Towers Systems™
 - BreezeBrellas™
 - Bleacher Covers
 - Dugouts/T-Styles
 - Side Panel Protectors
 - Cantilever Systems
 - Shade Park™
 - Shadow Wing™
 - Super Contemporary
 - Contemporary
- Custom Designed Units
- Our Accessories

Who can purchase from the state contract?

- County School Systems
- School Principals & Maintenance
- Parks & Recreation Departments
- Florida Agencies
- Florida Municipalities

Why should the state contract be utilized?

- It's a competitively bid contract.
- Eliminates writing specs, advertising, bid meetings & invitations.
- Ability to place orders when you need to.

How does the process work?

- Log on to the Florida State website:
www.myflorida.com/st_contracts/650001041
- Select the product fitting your needs or call us for assistance.
- Fax, mail or email your purchase order.

Sunguard Shade Structures Corp.

sales@sunguard.net • www.floridasunshade.com

1.800.319.1010 • 941.925.3000

As you know, sun safety has become an integral part of play area safety for our children. Skin cancer rates are rising and the solar uv exposure to children is a leading contributor. Shade is the best preventative, and can be provided by trees, buildings, or Sunguard Shade Structure Units. Regardless of the source insist that facilities your children play at provide shade.

Protect Yourself from the Sun

- **Stay in the shade whenever possible.**
The sun's rays are strongest between the hours of 10 a.m. and 4 p.m.
- **No shadow...seek the shade!**
If your shadow is shorter than you are, you're likely to burn.
- Wear protective, tightly woven clothing, such as a long-sleeved shirt and pants.
- Apply a broad-spectrum sunscreen with a Sun Protection Factor (SPF) of at least 15.
- Reapply sunscreen every 2 hours when outdoors, even on cloudy days.
- Wear a wide-brimmed hat and sunglasses when outdoors.





1 in 5 children will grow up to have some form of skin cancer.

shade park
double row
shade park double row

shade park
single row
shade park single row

shadow wing
shadow wing

super
contemporary
super
contemporary

contemporary
contemporary

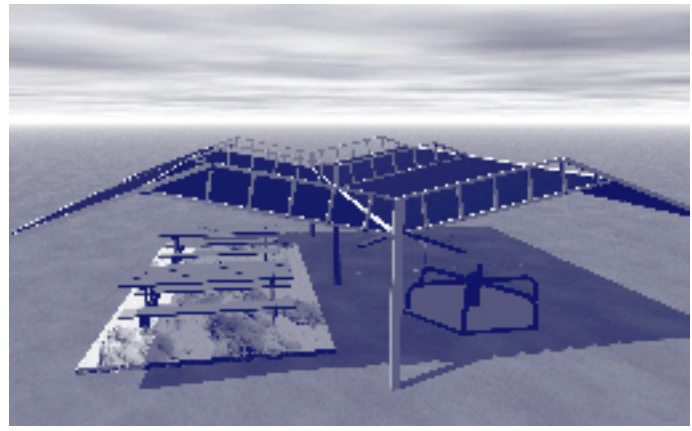

Park/Playground Equipment
Conceptual Rendering

Lengths of 18' to 20'

Projections of 34' to 40'

Type ¹	Model #	Length	Projection	Height ²	Finish	Weight ³	Retail	State ⁴
Master	SP1820DMP	18' to 20'	34' to 40'	7'7" to 8'	Powder Coat	1,723	\$10,157	\$7,617
Add On	SW1820DAP	18' to 20'	34' to 40'	7'7" to 8'	Powder Coat	1,130	\$6,480	\$4,860
Master	SP1820DMG	18' to 20'	34' to 40'	7'7" to 8'	Galvanized	1,723	\$8,128	\$6,096
Add On	SW1820DAG	18' to 20'	34' to 40'	7'7" to 8'	Galvanized	1,130	\$5,177	\$3,882

Lengths of 21' to 23'

Projections of 34' to 40'

Type ¹	Model #	Length	Projection	Height ²	Finish	Weight ³	Retail	State ⁴
Master	SP2120DMP	21' to 23'	34' to 40'	7'7" to 8'	Powder Coat	1,723	\$11,299	\$8,474
Add On	SP2120DAP	21' to 23'	34' to 40'	7'7" to 8'	Powder Coat	1,130	\$7,200	\$5,400
Master	SP2120DMG	21' to 23'	34' to 40'	7'7" to 8'	Galvanized	1,723	\$9,038	\$6,779
Add On	SP2120DAG	21' to 23'	34' to 40'	7'7" to 8'	Galvanized	1,130	\$5,760	\$4,320

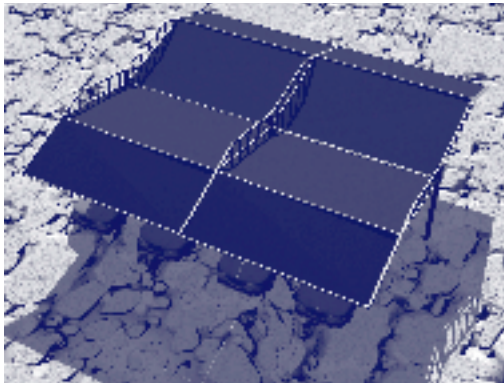

Conceptual Rendering
Top View

¹ Unit Type
² Standard entry heights of 7'7" to 9' are available
³ Approximate Shipping Weight (lbs).
⁴ Florida State Discount of 25%.

Footing Specifications for surface mounting with New Footing

Depth of 4'x3'x2'; Re-bar (each way): 7-#5; A 307 Anchor Bolts 1"x1' with leveling nuts

Prices include surface mount plates.

Additional layout fee may be required depending upon the size of the project.

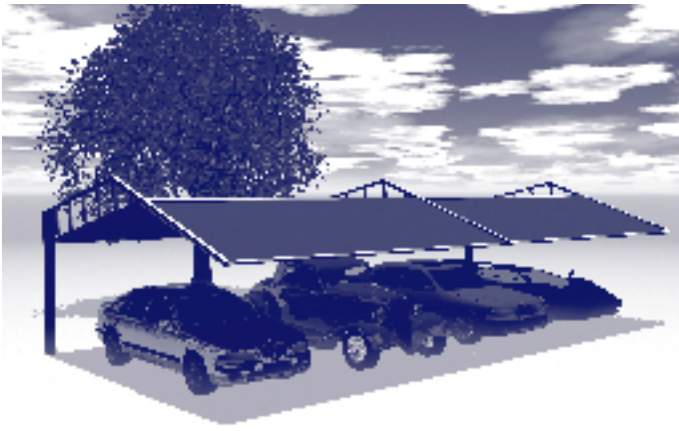

Conceptual Rendering



shade park: single row

Lengths of 18' to 20'

Projections of 17' to 20'

Type ¹	Model #	Length	Projection	Height ²	Finish	Weight ³	Retail	State ⁴
Master	SP1820SMP	18' to 20'	17' to 20'	7'7" to 8'	Powder Coat	1,066	\$5,355	\$4,016
Add On	SP1820SAP	18' to 20'	17' to 20'	7'7" to 8'	Powder Coat	670	\$4,522	\$3,392
Master	SP1820SMG	18' to 20'	17' to 20'	7'7" to 8'	Galvanized	1,066	\$4,284	\$3,213
Add On	SP1820SAG	18' to 20'	17' to 20'	7'7" to 8'	Galvanized	670	\$3,624	\$2,718

Lengths of 21' to 23'

Projections of 17' to 20'

Type ¹	Model #	Length	Projection	Height ²	Finish	Weight ³	Retail	State ⁴
Master	SP2123SMP	21' to 23'	17' to 20'	7'7" to 8'	Powder Coat	1,066	\$6,010	\$4,507
Add On	SP2123SAP	21' to 23'	17' to 20'	7'7" to 8'	Powder Coat	670	\$5,040	\$3,780
Master	SP2123SMG	21' to 23'	17' to 20'	7'7" to 8'	Galvanized	1,066	\$4,790	\$3,592
Add On	SP2123SAG	21' to 23'	17' to 20'	7'7" to 8'	Galvanized	670	\$4,034	\$3,026

¹Unit Type

²Standard entry heights of 7'7" to 9' are available

³Approximate Shipping Weight (lbs).

⁴Florida State Discount of 25%.

Footing Specifications for surface mounting with New Footing

Depth of 4'x3'x2'; Re-bar (each way): 7-#5; A 307 Anchor Bolts 1"x1' with leveling nuts

Prices include surface mount plates.

Additional layout fee may be required depending upon the size of the project.

Woodland Baptist Child Center
Bradenton, FL



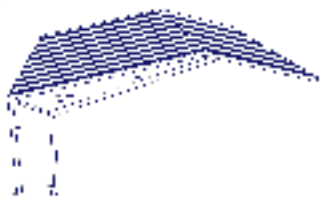

SHADOW WING



Sunguard Shade Structures
Sarasota, FL

Lengths of 18' to 20'

Projections of 16' to 20'

Type ¹	Model #	Length	Projection	Area ²	Finish	Weight ³	Retail	State ⁴
Master	SW1820MP	18' to 20'	16' to 20'	288' to 463'	Powder Coat	675	\$4,510	\$3,383
Add On	SW1820AP	18' to 20'	16' to 20'	288' to 463'	Powder Coat	465	\$3,451	\$2,588
Master	SW1820MG	18' to 20'	16' to 20'	288' to 463'	Galvanized	675	\$3,558	\$2,669
Add On	SW1820AG	18' to 20'	16' to 20'	288' to 463'	Galvanized	465	\$2,856	\$2,142

Lengths of 21' to 23'

Projections of 16' to 20'

Type ¹	Model #	Length	Projection	Area ²	Finish	Weight ³	Retail	State ⁴
Master	SW2120MP	21' to 23'	16' to 20'	288' to 463'	Powder Coat	675	\$4,980	\$3,735
Add On	SW2120AP	21' to 23'	16' to 20'	288' to 463'	Powder Coat	465	\$3,749	\$2,811
Master	SW2120MG	21' to 23'	16' to 20'	288' to 463'	Galvanized	675	\$3,969	\$2,976
Add On	SW2120AG	21' to 23'	16' to 20'	288' to 463'	Galvanized	465	\$3,094	\$2,321



Sunguard Shade Structures
Sarasota, FL

¹ Unit Type
² Area (sq ft)
³ Approximate Shipping Weight (lbs).
⁴ Florida State Discount of 25%.

Footing Specifications for surface mounting
Depth of 4'x3'x18"; Re-bar (each way): 5-#5; Wedge Anchor (Red Head) True Bolt 5/8" x 8 1/2" N; Epoxy Bond: Epcor Ramset R-6 (or equivalent); Existing concrete slab: 4" (minimum).
Sizing Specifications for surface mounting
Lengths of 18'-20'; widths of 16'-20'; Square Footage of 288'-463'; Front Heights of 7'7"-8' and Rear Heights of 7'2"-8'2".
Prices include surface mount plates.
Additional layout fee may be required depending upon the size of the project.

Type ¹	Model #	Size ²	Finish	Weight ³	Retail	State ⁴
Master	SCC2020MP	20'x20'	Powder Coat	925	\$6,069	\$4,552
Add On	SCC2020AP	20'x20'	Powder Coat	925	\$3,998	\$2,999
Master	SCC2020MG	20'x20'	Galvanized	925	\$4,498	\$3,374
Add On	SCC2020AG	20'x20'	Galvanized	925	\$2,880	\$2,160



super contemporary

¹ Unit Type
² All dimensions given are Length x Projection. Available heights are 7' to 10'. <i>Note: As the height increases in our structures, the wind loads also increase, requiring stronger specifications. Super Contemporaries are available in 20'x20', 18'x18' and 18'x20', price on request.</i>
³ Approximate Shipping Weight (lbs); subject to change.
⁴ Florida State Discount of 25%.
All Super Contemporary Units are Surface Mount only.
Additional layout fee may be required depending upon the size of the project.

super contemporary

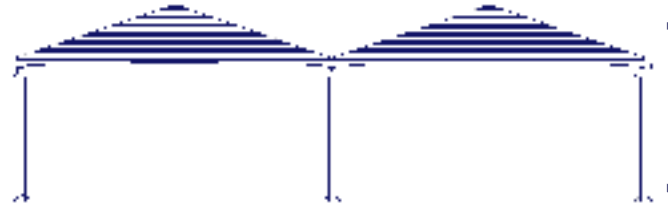

Pohick Golf Course
Virginia

Type ¹	Model #	Size ³	Finish	Weight ⁴	Retail	State ⁵
Master ²	CC2040MP	40'x20'x7'	Powder Coat	1,230	\$9,377	\$7,033
Add On	CC2040AP	40'x20'x7'	Powder Coat	1,130	\$6,997	\$5,248
Master ²	CC2040MG	40'x20'x7'	Galvanized	1,230	\$6,747	\$5,060
Add On	CC2040AG	40'x20'x7'	Galvanized	1,130	\$5,129	\$3,847



contemporary

¹ Unit Type
² Master Units are available in 40'x20' due to height.
³ All dimensions given are Length x Projection x Height (max. of 7').
⁴ Approximate Shipping Weight (lbs).
⁵ Florida State Discount of 25%.
All Contemporary Units are Surface Mount only.
Additional layout fee may be required depending upon the size of the project.

contemporary



Grand Lakes Resort
Ritz-Marriott
Orlando, FL



Grand Lakes Resort
Orlando, FL

Tuttle Elementary School
Sarasota, FL



posts
pads
post pads

replacement
covers
replacement covers

logos heating
mistings
logos misting heating-lighting

surface
mount plates
surface mount plates

Post Pads

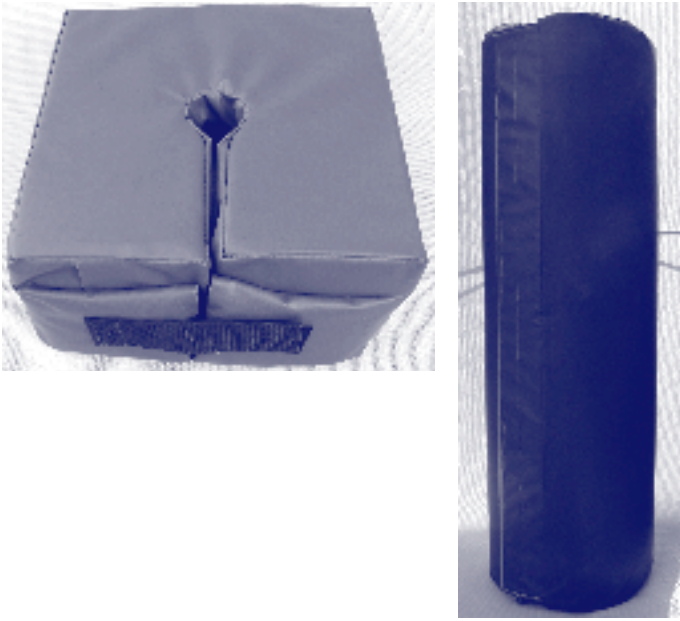

Item #	Sizes	Retail & State
Post Pads	call style sizes	varies depending upon style, call for quote

Replacement Covers

Replacement Cover Only		
Item #	Retail	State ¹
RC ³	\$4	\$3

Replacement Cover with Cable & Clamps		
Item #	Retail	State ¹
RCC ³	\$5	\$4

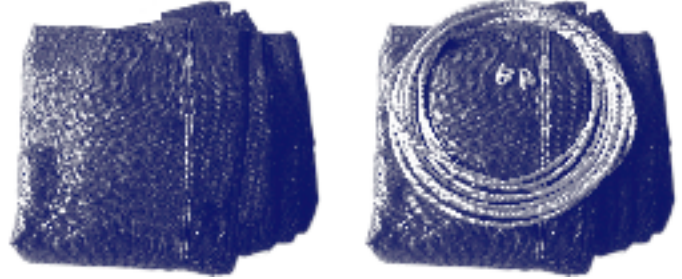

¹Florida State Discount of 25%.

Prices for Replacement Covers are per square foot.

Additional Options

Item #	Retail & State
Logos	varies depending upon job, call for quote
Misting Systems	varies depending upon job, call for quote
Heating Systems	varies depending upon job, call for quote
Lighting Systems	varies depending upon job, call for quote



Ashton Elementary School
Sarasota, FL



Lackland Air Force Base
Misting System
San Antonio, TX

Surface Mount Plate

Item #	Retail	State ¹
SM ³	\$71	\$54

¹Florida State Discount of 25%.

Prices listed are for one (1) surface mount plate each.

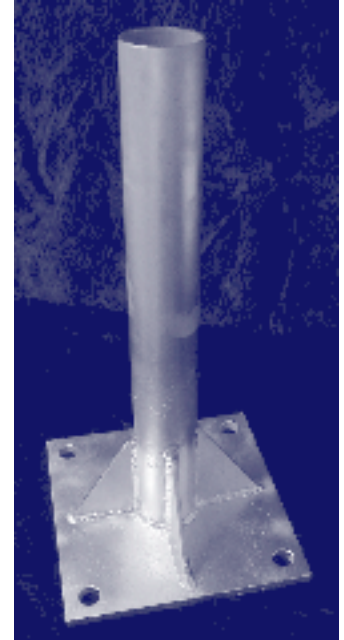

surface
mount
new footings

surface
mount
existing footings

direct
imbedment

sleeve
imbedment

imbedment options

sleeve imbedment

This mounting is available for the BreezeBrella™ units only.

Incorrect installation voids all warranties.

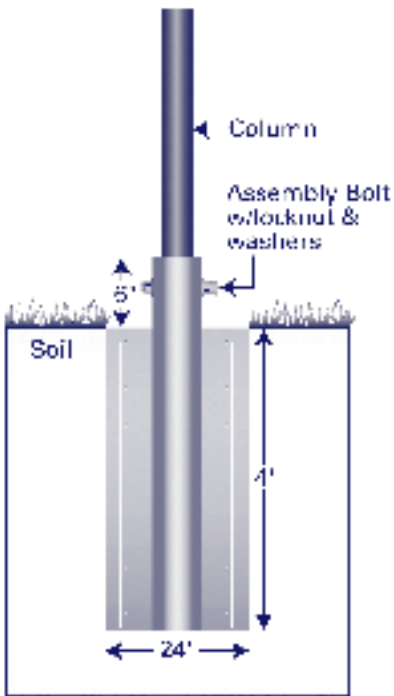

direct imbedment

Installation requires posts to be imbedded in a concrete footing in bare soil.

Footings are specified, but are not provided.

Incorrect installation voids all warranties.

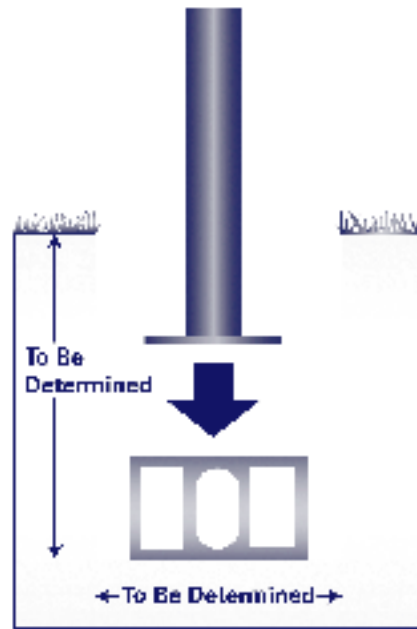

surface mount options

new footings

Units can be surface mounted on new footings poured to specifications.

Footing requirements vary according to structure size. Please call for specifications.

Incorrect installation voids all warranties.

J-bolts are not supplied by Sunguard Shade Structures Corp.

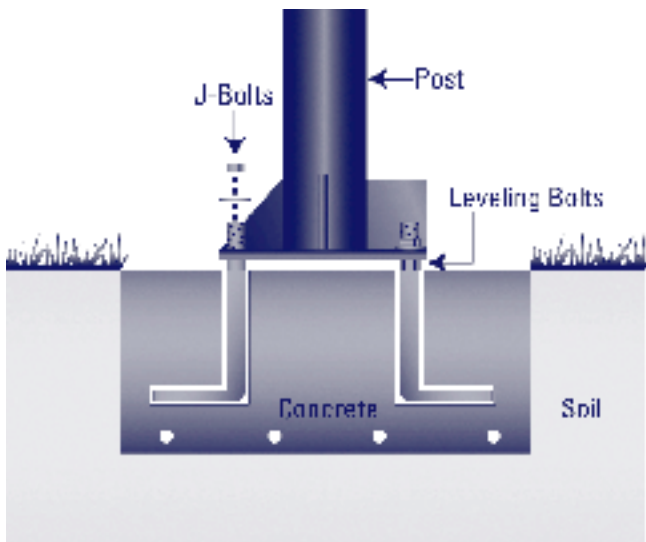

existing

Units can be surface mounted on a 4" (minimum) existing concrete slab.

Slab requirements vary according to structure size. Please call for specifications.

(Each post must be 1' from any edge. For example, a 25'x25' pad takes a 23'x23' unit.)

Incorrect installation voids all warranties.

Anchor bolts are not supplied by Sunguard Shade Structures Corp.

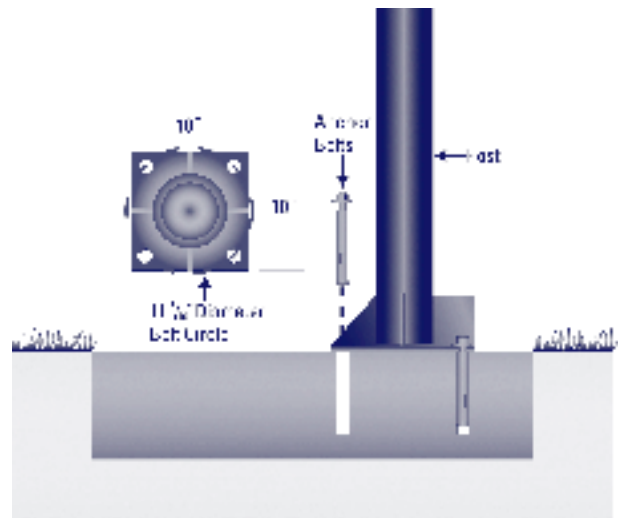



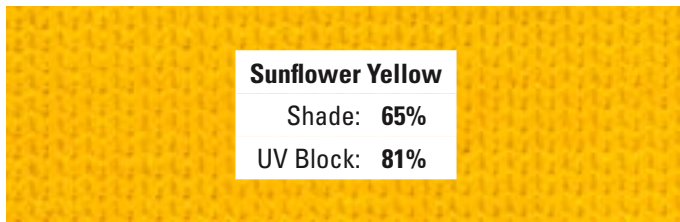
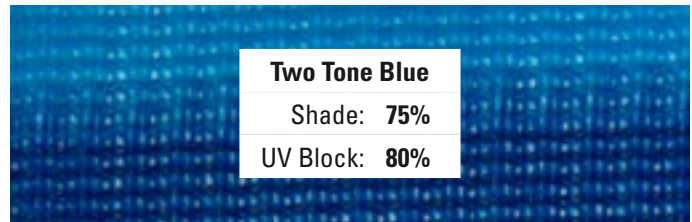
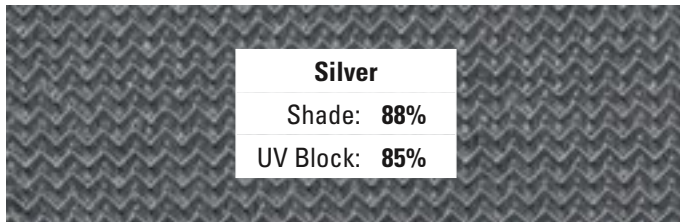
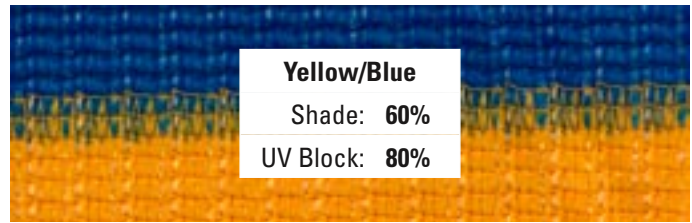
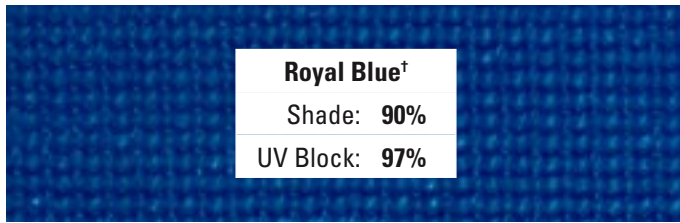
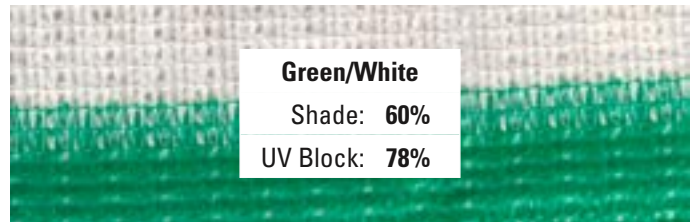
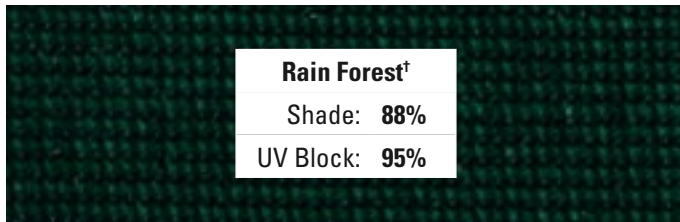
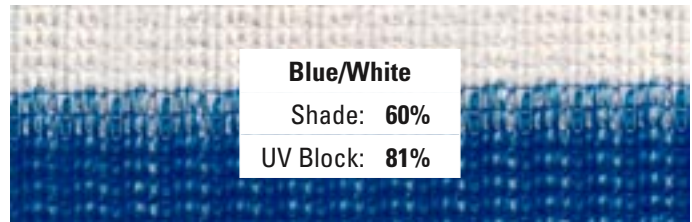
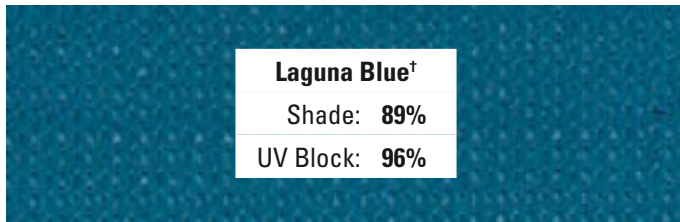
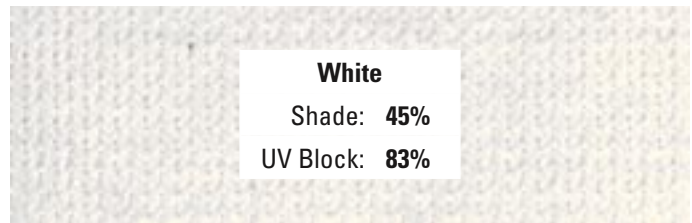
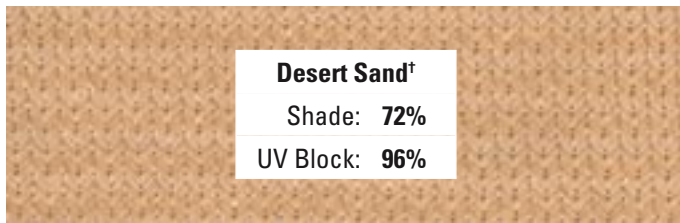
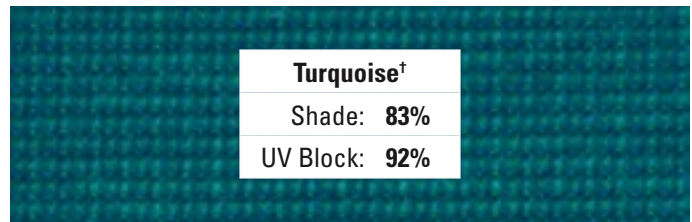
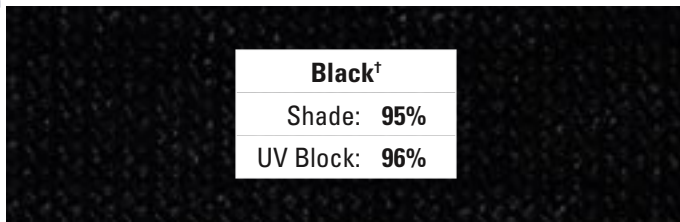
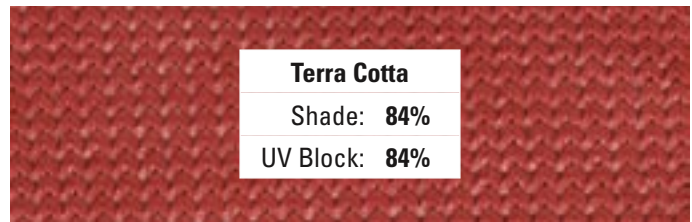
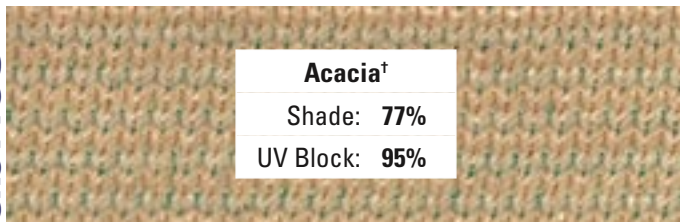

[†]Indicates fabrics certified by an independent laboratory to meet AMC Cancer Research Center guidelines.

Due to variations in printing techniques and monitors, colors may be different than they appear. Please contact Sunguard Shade Structures Corp. for a swatchbook.

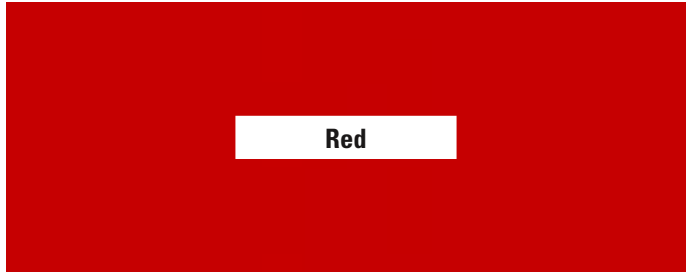
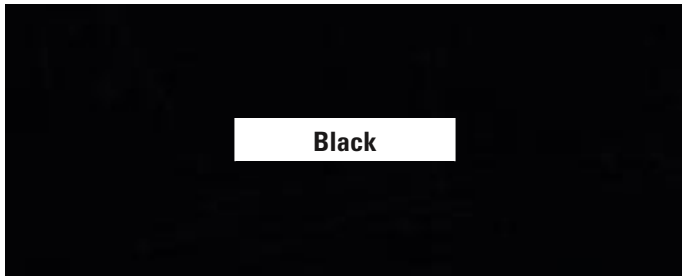

Due to variations in printing techniques, monitor calibrations, and manufacturer techniques colors may be different than they

appear. Please contact Sunguard Shade Structures Corp. for a swatchbook.



Woodmere Park
Venice, FL



Fountain Apartments
Venice, FL



Englewood Sports Complex
Englewood, FL



Nokomis Park
Nokomis, FL



St Mark's Church
Venice, FL

Sarasota Growers
Sarasota, FL



Warranty

Sunguard Shade Structures' fabrics are warranted for 10 years against failure due to rot, UV deterioration, or faulty workmanship. **This warranty is non-prorated.** Steel frames are warranted for 20 years against failure due to corrosion, deterioration or faulty workmanship. This warranty does not cover vandalism, failure to provide routine maintenance, nor Acts of God. **Cover must be removed in winds expected to exceed 75 mph. Incorrect installation voids all warranties.**

General Notes

Units are designed for perimeter posts only. All units are clear span—no center support posts necessary. Most units require only four (4) posts, however, larger units and extra tall units may require additional perimeter posts.

Sunguard has over 600 standard sizes and shapes—all professionally engineered to meet national building codes and wind load requirements ASCE 7-02 (ASD, LRFD). If you don't see the size you are looking for, please call for a quote from our data bank. Prices are subject to change.

Packaging & Handling

Standard packaging and handling is included in the net price listed. Additional packaging is required west of the Mississippi River, add \$60 per unit.

Powder Coat Finishes

Sunguard proudly provides a top quality, cold-rolled, flo-coat galvanized finish as standard on all units. Customers may select one of our 10 standard powder coat colors as an alternative finish. Custom colors are available, customer must provide a swatch for matching.

Custom colors.....+10% to list price

Terms & Conditions

Prices FOB—Sarasota, Florida

4%—discount when full payment is received with order.

Net 30—from date of invoice to all government agencies and those with approved credit.

Note—Accounts exceeding 30 days of invoice will be billed finance charges at the rate of 1.5% of unpaid balance with a minimum \$25 charge.

Installation & freight are not included in the prices listed.

Ordering

When ordering, we **must** have six (6) essential items of information:

- 1) Model Number
- 2) Fabric Color
- 3) Steel Finish
- 4) Installation (Mounting Type)
- 5) Post Height
- 6) Most Recent Site Plan or Survey with all playground equipment noted (when requesting sealed drawings)

Attention Designers

All squares, rectangles and triangles can be connected to expand coverage or to meet architectural requirements. Units are connected by special interconnecting posts. Calculate price by using standard unit prices of the units being connected. Please specify on the purchase order that you want interconnecting units.

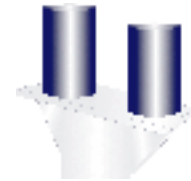

Sealed Drawings

If a sealed drawing is required a **site plan or survey must be included with the order, electronic format preferred.** All existing structures, including playground equipment must be noted. Additional charges will be incurred for sealed drawings.

Custom Applications

Sunguard Shade Structures' product designers and engineers can design units to meet most requirements. Send us a survey, a site plan or a proposal and we will be glad to give you a quote and preliminary design. We can custom design for snow loads and wind loads up to 170mph.

Post Height

Additional post heights of 9'-12' are available, please call for a custom quote. Remember, the higher the posts, the smaller the shade pattern; use the lowest height consistent with obstacle clearance possible.

Price List

Effective August 01, 2005



www.floridasunshade.com

sales@sunguard.net

1.800.319.1010

*This price list supercedes all previous price changes.
Information & pricing subject to change without notice.*

Premier Manufacturer of Shade Structures ● *Promoting Sun Safety & Cool Comfort*