

# *Price List*

**Effective August 01, 2005**



**Sunguard Shade Structures  
CORPORATION**

*www.floridasunshade.com*  
*sales@sunguard.net*  
*1.800.319.1010*

***Premier Manufacturer of Shade Structures***

***Promoting Sun Safety & Cool Comfort***

# Contact & Contents

Address	4487 B Ashton Rd • Sarasota FL 32433
Toll Free	1.800.319.1010
Phone	941.925.3000
Fax	941.925.3001
Web Site	www.floridasunshade.com
email	sales@sunguard.net



I personally received and opened the boxes to the shade structures and personally installed one. I just wanted to thank you personally for your efforts in getting them to me on time. I've attached a picture of the one that I assembled, it looks great and was very easy to do.

Thank You



## Florida State Contract

Contract	650-001-04-1
Toll Free	1.800.319.1010
Phone	941.925.3000
Fax	941.925.3001
Web Site	www.floridasunshade.com
email	sales@sunguard.net

	Page	Type
Contact Information	2	Information
Contents	2	Information
Why Sunguard?	3	Information
Florida State Contract	4	Information
Sun Safety	5	Information
Rectangles	8	Standard
Squares	9	Standard
Triangles	10	Standard
Hexagons	11	Standard
Octagons	12	Standard
Star-Octagons	12	Standard
BreezeBrellas	13	Umbrellas
Play Towers	14	Playground Towers
3-Row Bleacher Covers	16	Bleachers
5-Row Bleacher Covers	17	Bleachers
10-Row Bleacher Covers	18	Bleachers
T-Styles	19	Dugouts & Benches
Side Panels	20	Protection
Shade Park: Double Row	22	Cantilevers
Shade Park: Single Row	23	Cantilevers
Shadow Wing	24	Cantilevers
Super Contemporary	25	Cantilevers
Contemporary	25	Cantilevers
Custom Designs	28	Custom Units
Heating Systems	30	Accessories
Lighting Systems	30	Accessories
Logos	30	Accessories
Misting Systems	30	Accessories
Post Pads	30	Accessories
Replacement Covers	30	Accessories
Surface Mount Plates	30	Accessories
Direct Imbedment	32	Installation
Sleeve Imbedment	32	Installation
Surface (existing pad)	32	Installation
Surface (new footings)	32	Installation
Fabrics	34	Information
Frames	35	Information
Custom Applications	36	Information
General Notes	36	Information
How To Order	36	Information
Sealed Drawings	36	Information
Warranty	36	Information

### *Best Quality Steel*

*Sunguard Shade Structures, Corp., exclusively uses Allied Steel products;* cold-rolled, galvanized tubular steel with a triple layer of protection. Allied products outperform most steels in tensile strength and long-term corrosion resistance. In saltwater spray and other weathering tests, Allied Steel outperforms the competition.

### *The Welds*

Sunguard uses a special galvanized welding wire and then triple treats each weld for extra corrosion protection.

### *Best Quality Fabric*

Sunguard Shade Cloth fabric is known for its' great strength, vibrant colors and durability. Our covers are made from *high-density polyethylene with ultraviolet additives, using mono filament and tape construction.* Sunguard covers are *rachel knitted* which ensures fabric stability and prevents the fabric from fraying, even when cut. This special knitting also ensures a consistent shade pattern.

Technical specs:

- Fabric Burst Strength: 260 KPA
- Tear Strength: 100 KG (warp)
- 210 KG (weft)

### *The Corners*

Sunguard *triple reinforces all connecting points.* Each connecting point has nylon webbing sewn in the interior to further reinforce the corner. In addition, the corners are designed to conceal the tensioning cable to give clean, smooth lines.

### *The Thread*

Sunguard uses a Teflon (PTFE) thread from the W. L. Gore Company, which will not deteriorate in the sun. The thread carries a lifetime guarantee and will not rot due to ultraviolet exposure or other environmental causes.

### *The Warranty*

Sunguard Shade Structures, Corp., has the best warranty in the industry. *We warranty all steel framework for 20 years and all fabric covers for 10 years.* For further information, please see our Certificate of Warranty. *This is a non-prorated warranty.*

### *Fire Safety*

Sunguard fabrics pass the E-84 fire rating test as well as the NFPA-701 and are rated a Class 1 Material.

### *The Cable*

Sunguard uses a special galvanized cable that is UV stabilized to tension the fabric perimeter. This ensures long-term durability for the cable and the fabric.

### *Ultra-Violet Protection*

Sunguard is the only shade company to have its cloth *tested by an independent laboratory* to verify and certify that its cloth blocks 90% or more of the cancer causing UV radiation. All colors that pass this stringent test are indicated on our brochures.

### *Engineering*

Sunguards are designed to meet the toughest building codes in the world! *Sunguards are routinely engineered to meet 120 mph wind loads!* They are also designed from 140 mph to 170 mph wind-borne debris regions as specified by the American Society of Civil Engineers Standard (ASCE 7-02).



## Shade Structures

### Annual State Contract *Frequently Asked Questions*

Contract #650-001-04-1

What products are offered on the state contract?

- Our Standard Units
  - Rectangles
  - Squares
  - Triangles
  - Hexagons
  - Octagons
  - Star-Octagons
  - Safe Fun in the Sun Shade Towers Systems™
  - BreezeBrellas™
  - Bleacher Covers
  - Dugouts/T-Styles
  - Side Panel Protectors
  - Cantilever Systems
    - Shade Park™
    - Shadow Wing™
    - Super Contemporary
    - Contemporary
- Custom Designed Units
- Our Accessories

Who can purchase from the state contract?

- County School Systems
- School Principals & Maintenance
- Parks & Recreation Departments
- Florida Agencies
- Florida Municipalities

Why should the state contract be utilized?

- It's a competitively bid contract.
- Eliminates writing specs, advertising, bid meetings & invitations.
- Ability to place orders when you need to.

How does the process work?

- Log on to the Florida State website:  
[www.myflorida.com/st\\_contracts/650001041](http://www.myflorida.com/st_contracts/650001041)
- Select the product fitting your needs or call us for assistance.
- Fax, mail or email your purchase order.

**Sunguard Shade Structures Corp.**

**sales@sunguard.net • www.floridasunshade.com**

**1.800.319.1010 • 941.925.3000**

*As you know, sun safety has become an integral part of play area safety for our children. Skin cancer rates are rising and the solar uv exposure to children is a leading contributor. Shade is the best preventative, and can be provided by trees, buildings, or Sunguard Shade Structure Units. Regardless of the source insist that facilities your children play at provide shade.*

## Protect Yourself from the Sun

- **Stay in the shade whenever possible.**  
The sun's rays are strongest between the hours of 10 a.m. and 4 p.m.
- **No shadow...seek the shade!**  
If your shadow is shorter than you are, you're likely to burn.
- Wear protective, tightly woven clothing, such as a long-sleeved shirt and pants.
- Apply a broad-spectrum sunscreen with a Sun Protection Factor (SPF) of at least 15.
- Reapply sunscreen every 2 hours when outdoors, even on cloudy days.
- Wear a wide-brimmed hat and sunglasses when outdoors.





*1 in 5 children will grow up to have some form of skin cancer.*

3 row covers

5 row covers

10 row covers

t-styles

side panels

# 3 row bleachers

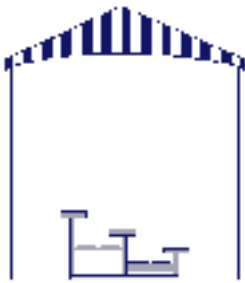

Bleacher Size		Cover Recommendation				
Length	Capacity	Model #	Unit Size <sup>1</sup>	Weight <sup>2</sup>	Retail	State <sup>3</sup>
15'	30	B1810G	18'x10'x8'	345	\$1,618	\$1,214
21'	42	B2410G	24'x10'x8'	378	\$2,118	\$1,589
27'	54	B3010G	30'x10'x8'	414	\$2,463	\$1,847

<sup>1</sup>All dimensions are listed Length x Width x Height (column)

<sup>2</sup>Approximate Shipping Weight (lbs).

<sup>3</sup>Florida State Discount of 25%.

Bleacher Unit prices are for Galvanized finish only. Powder coating available upon request.

**Prices are for Direct Imbedment only.**

Surface Mount Plates are \$54 each at Florida State Discount.



Cal Ripken Little League Complex  
Sarasota, FL

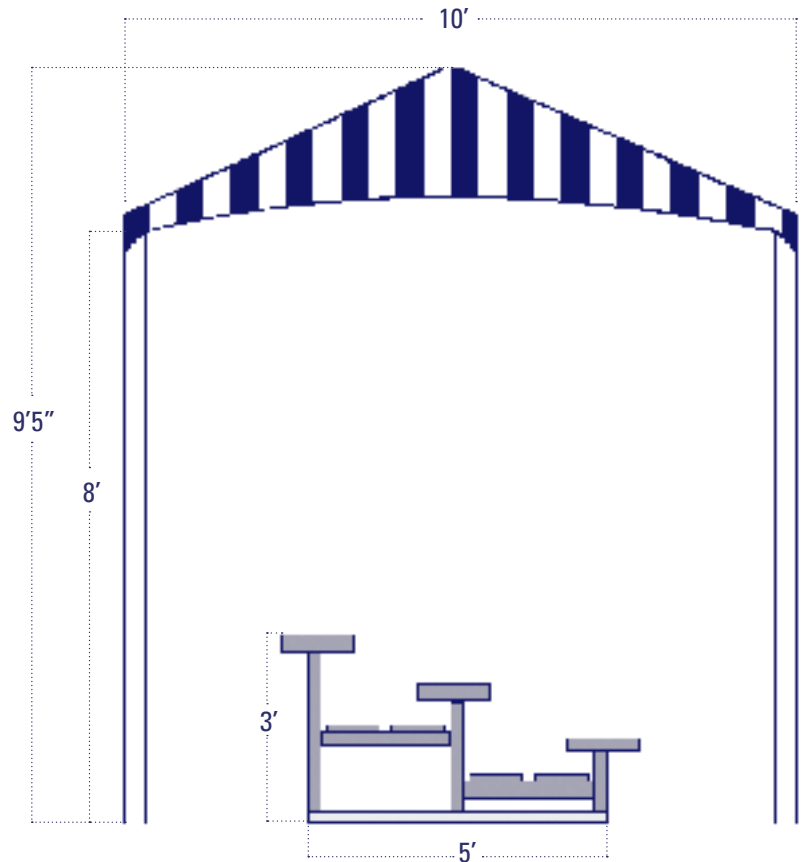



Bleacher Size		Cover Recommendation				
Length	Capacity	Model #	Unit Size <sup>1</sup>	Weight <sup>2</sup>	Retail	State <sup>3</sup>
15'	50	B1812G	18'x12'x9'	355	\$1,964	\$1,473
21'	70	B2412G	24'x12'x9'	410	\$2,440	\$1,830
27'	90	B3012G	30'x12'x9'	500	\$2,832	\$2,124

<sup>1</sup>All dimensions are listed Length x Width x Height (column)

<sup>2</sup>Approximate Shipping Weight (lbs).

<sup>3</sup>Florida State Discount of 25%.

Bleacher Unit prices are for Galvanized finish only. Powder coating available upon request.

**Prices are for Direct Imbedment only.**

Surface Mount Plates are \$54 each at Florida State Discount.

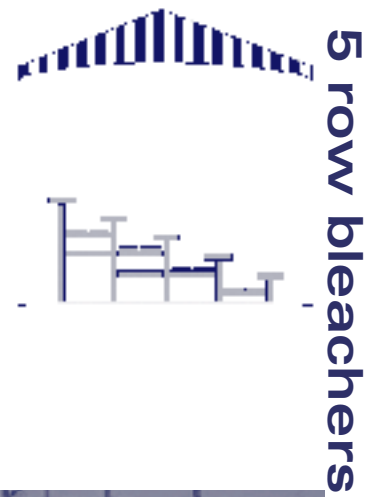

Braden River Little League  
Bradenton, FL

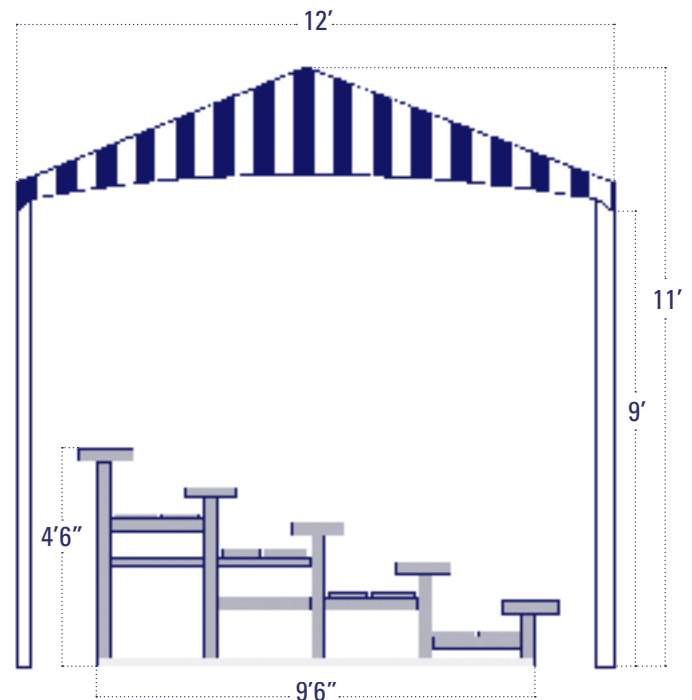

Cal Ripken Little League Complex  
Sarasota, FL

# 10 row bleachers



Bleacher Size		Cover Recommendation				
Length	Capacity	Model #	Unit Size <sup>1</sup>	Weight <sup>2</sup>	Retail	State <sup>3</sup>
15'	100	B2218G	18'x22'x12'	480	\$3,927	\$2,945
21'	140	B2422G	24'x22'x12'	528	\$4,879	\$3,659
27'	180	B3022G	30'x22'x12'	651	\$5,653	\$4,239

<sup>1</sup>All dimensions are listed Length x Width x Height (column)  
<sup>2</sup>Approximate Shipping Weight (lbs).  
<sup>3</sup>Florida State Discount of 25%.  
 Bleacher Unit prices are for Galvanized finish only. Powder coating available upon request.  
**Prices are for Direct Imbedment only.**  
 Surface Mount Plates are \$54 each at Florida State Discount.



Sarasota Redskins Football Complex



Cal Ripken Little League Complex  
FL

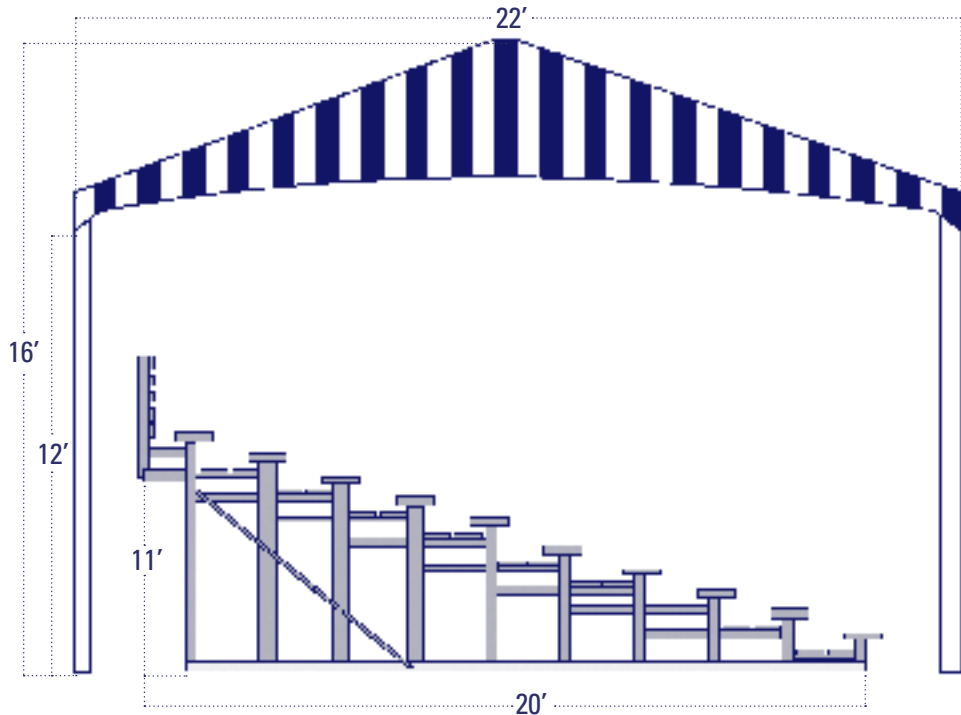

Model #	Unit Size <sup>1</sup>	Finish <sup>2</sup>	Weight <sup>3</sup>	Retail	State <sup>4</sup>
D1012G	10'x12'x8'	G	232	\$1,309	\$982
D1012P	10'x12'x8'	PC	232	\$1,535	\$1,151
D1016G	10'x16'x8'	G	260	\$1,452	\$1,089
D1016P	10'x16'x8'	PC	260	\$1,690	\$1,267
D1018G	10'x18'x8'	G	275	\$1,642	\$1,232
D1018P	10'x18'x8'	PC	275	\$1,892	\$1,419
D1020G	10'x20'x8'	G	295	\$1,714	\$1,285
D1020P	10'x20'x8'	P	295	\$1,964	\$1,473

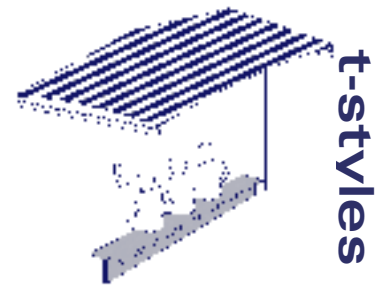

<sup>1</sup> Length x Width x Height (8' column)
<sup>2</sup> G (Galvanized); PC (Powder Coat)
<sup>3</sup> Approximate Shipping Weight (lbs).
<sup>4</sup> Florida State Discount of 25%.
<b>Prices are for Direct Imbedment only.</b>
Surface Mount Plates are \$54 each at Florida State Discount.



Ashton Elementary School  
Sarasota, FL



Fruitville Public Library Butterfly Garden  
Sarasota, FL



Automation Car Wash  
Houston, TX

side panels



Description	Retail	State <sup>1</sup>
3' Back Drop w/ grommets placed per customer specification	\$5 sq ft	\$4 sq ft

<sup>1</sup>Florida State Discount of 25%.

Protect the fans with our foul ball panel protectors. Side protection is provided by fabric protectors, which are suspended between any two posts using vinyl clad, galvanized steel cables and mounting hardware. Sports fans under Sunguard Shade structures can enjoy protection too!



St. Anne's School  
Charlottesville, VA



Grove City Parks & Recreation  
Grove City, OH



posts  
pads  
post pads

replacement  
covers  
replacement covers

logos heating  
mistings  
logos misting heating-lighting

surface  
mount plates  
surface mount plates

Post Pads

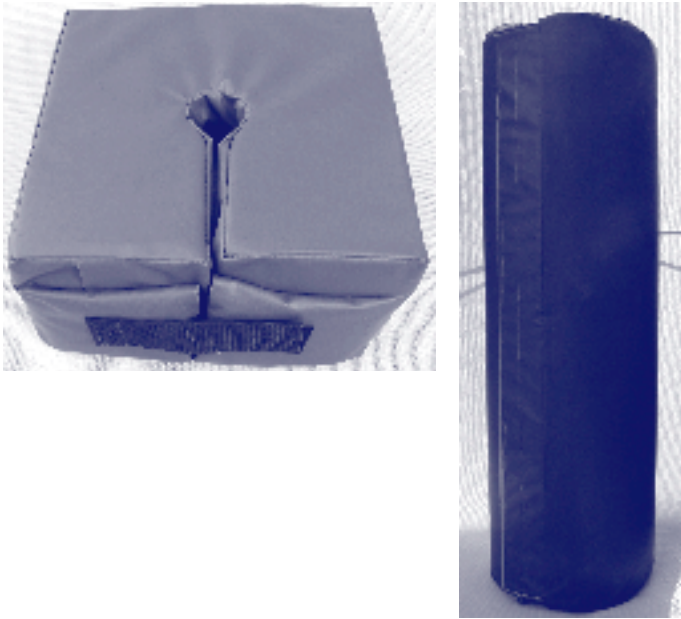

Item #	Sizes	Retail & State
Post Pads	call style sizes	varies depending upon style, call for quote

Replacement Covers

Replacement Cover Only		
Item #	Retail	State <sup>1</sup>
RC <sup>3</sup>	\$4	\$3

Replacement Cover with Cable & Clamps		
Item #	Retail	State <sup>1</sup>
RCC <sup>3</sup>	\$5	\$4

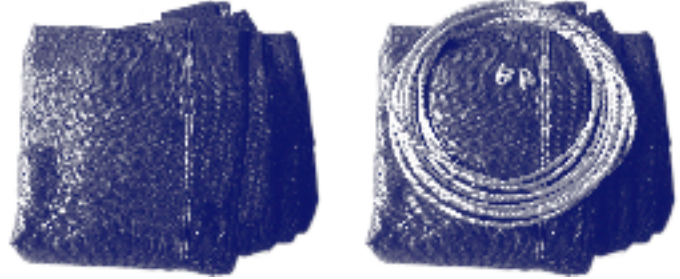

<sup>1</sup>Florida State Discount of 25%.  
 Prices for Replacement Covers are per square foot.

Additional Options

Item #	Retail & State
Logos	varies depending upon job, call for quote
Misting Systems	varies depending upon job, call for quote
Heating Systems	varies depending upon job, call for quote
Lighting Systems	varies depending upon job, call for quote



Ashton Elementary School  
 Sarasota, FL



Lackland Air Force Base  
 Misting System  
 San Antonio, TX

Surface Mount Plate

Item #	Retail	State <sup>1</sup>
SM <sup>3</sup>	\$71	\$54

<sup>1</sup>Florida State Discount of 25%.  
 Prices listed are for one (1) surface mount plate each.

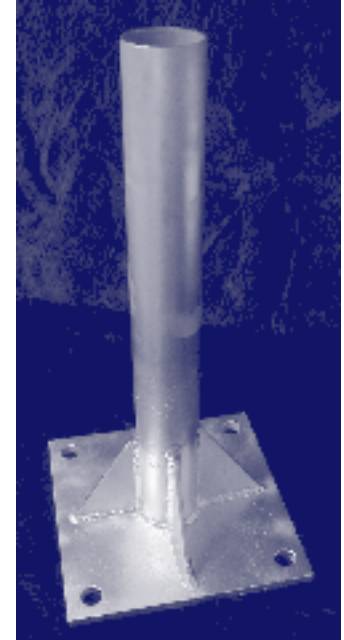

surface  
mount  
new footings

surface  
mount  
existing footings

direct  
imbedment

sleeve  
imbedment

imbedment options

## sleeve imbedment

This mounting is available for the BreezeBrella™ units only.

**Incorrect installation voids all warranties.**

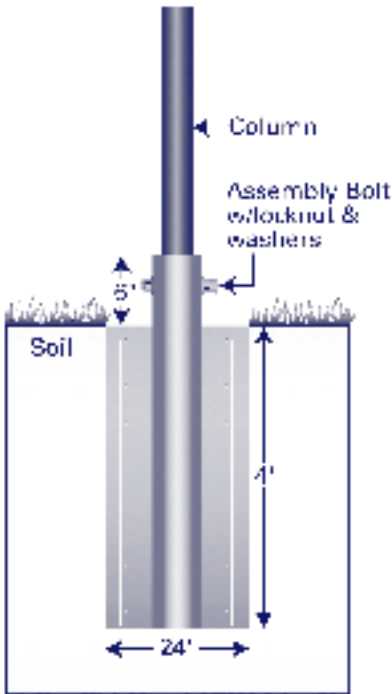

## direct imbedment

Installation requires posts to be imbedded in a concrete footing in bare soil.

Footings are specified, but are not provided.

**Incorrect installation voids all warranties.**

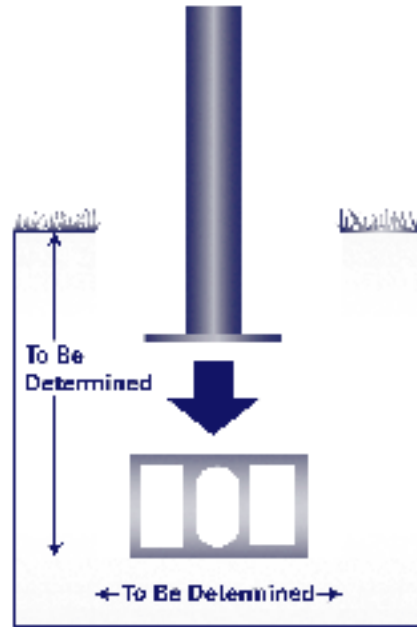

surface mount options

## new footings

Units can be surface mounted on new footings poured to specifications.

Footing requirements vary according to structure size. Please call for specifications.

**Incorrect installation voids all warranties.**

J-bolts are not supplied by Sunguard Shade Structures Corp.

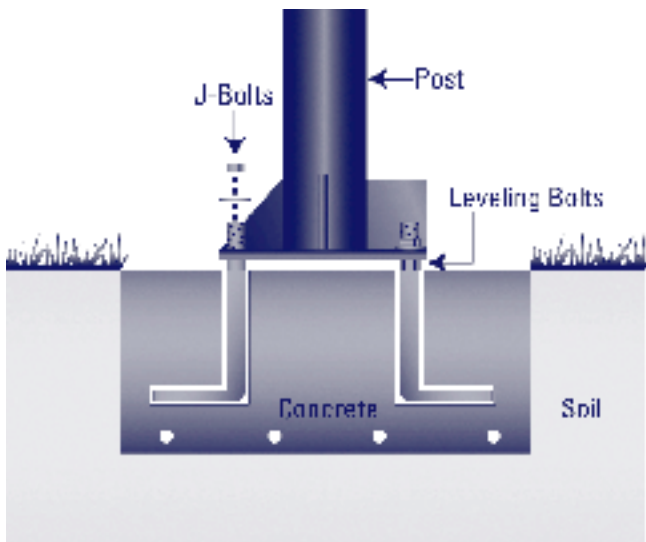

## existing

Units can be surface mounted on a 4" (minimum) existing concrete slab.

Slab requirements vary according to structure size. Please call for specifications.

(Each post must be 1' from any edge. For example, a 25'x25' pad takes a 23'x23' unit.)

**Incorrect installation voids all warranties.**

Anchor bolts are not supplied by Sunguard Shade Structures Corp.

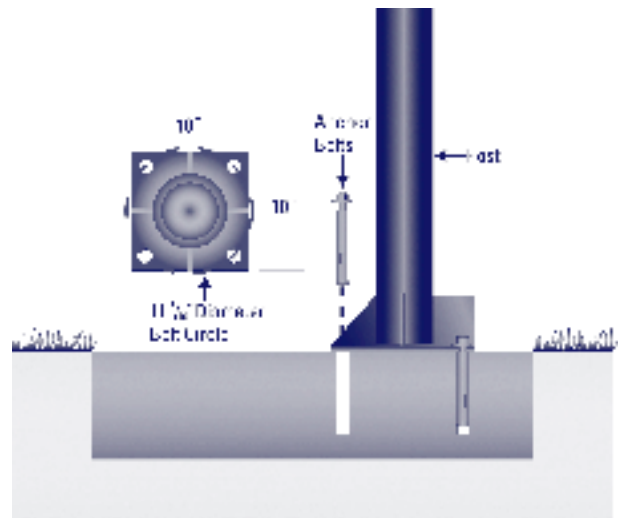





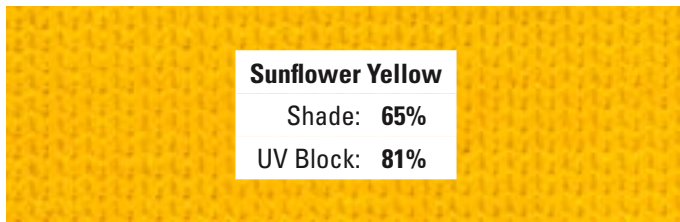
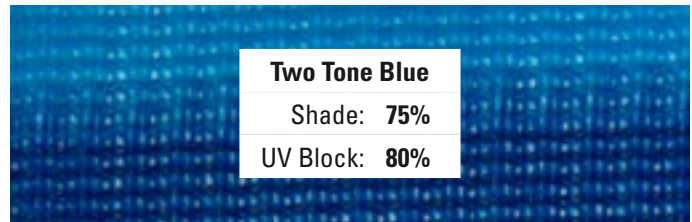
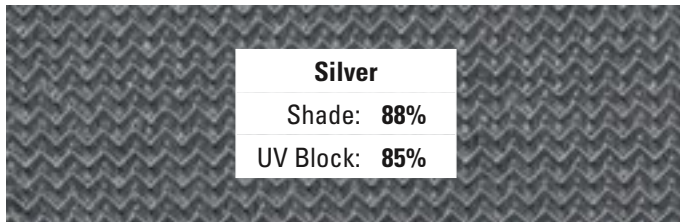
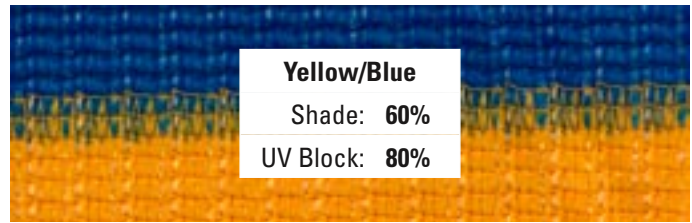
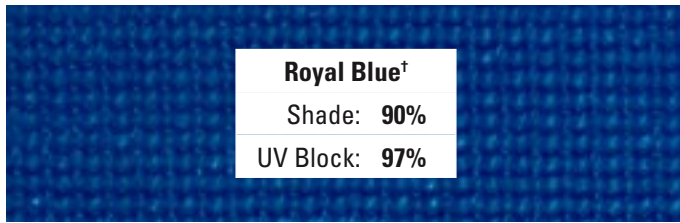
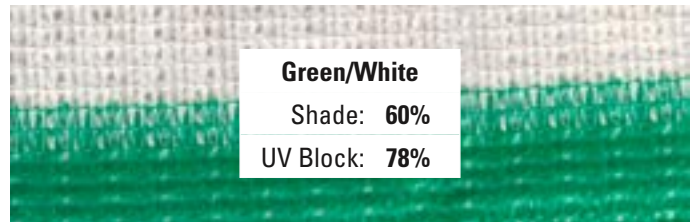
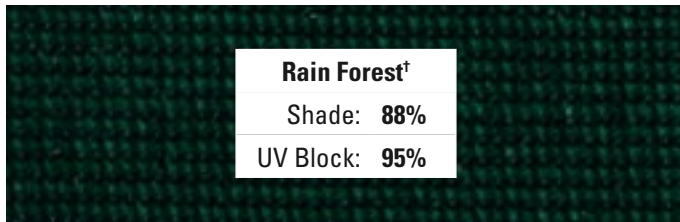
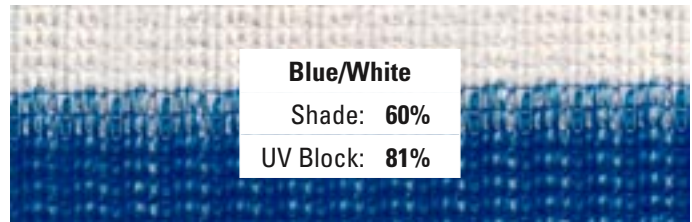
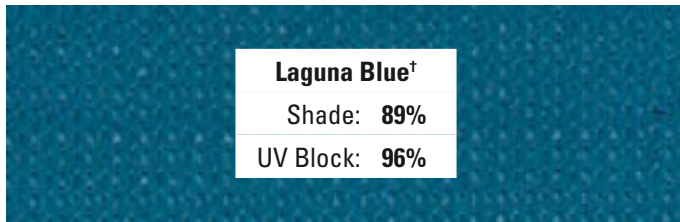
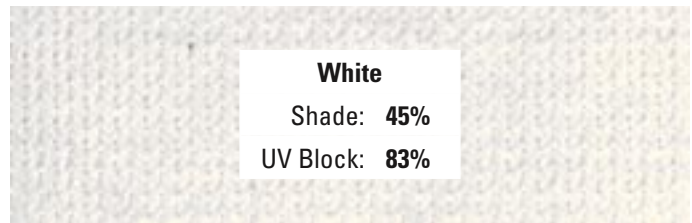
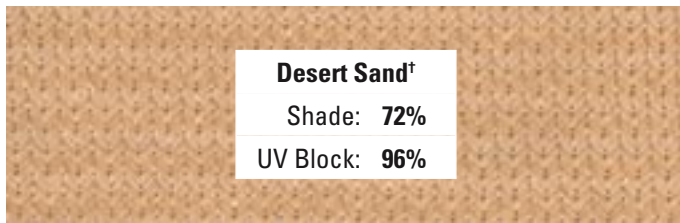
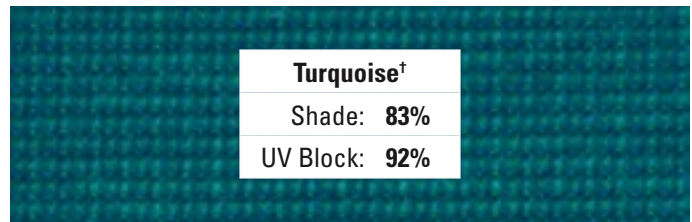
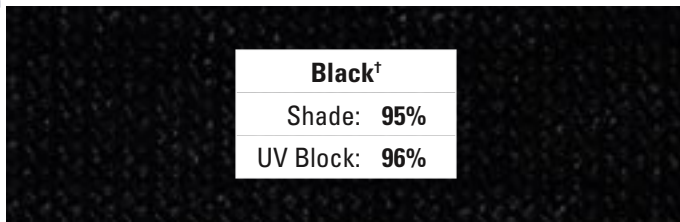
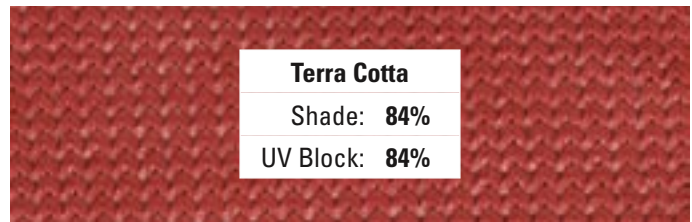
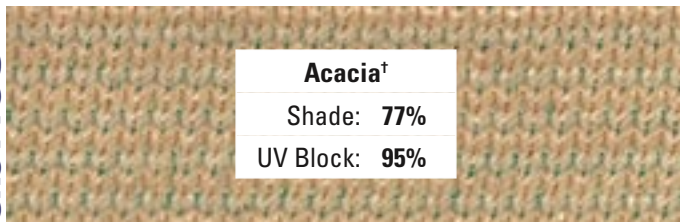

<sup>†</sup>Indicates fabrics certified by an independent laboratory to meet AMC Cancer Research Center guidelines.

Due to variations in printing techniques and monitors, colors may be different than they appear. Please contact Sunguard Shade Structures Corp. for a swatchbook.

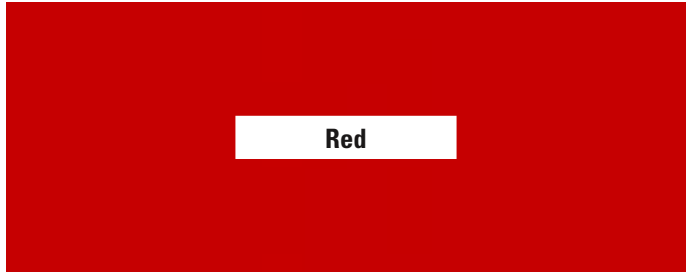
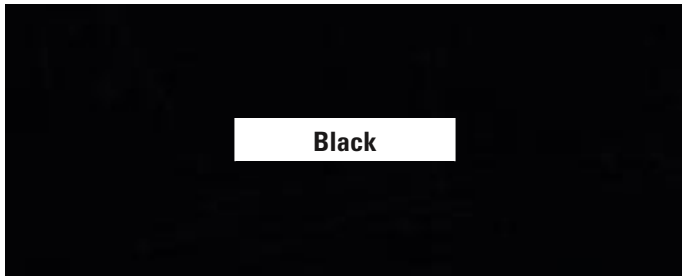

Due to variations in printing techniques, monitor calibrations, and manufacturer techniques colors may be different than they

appear. Please contact Sunguard Shade Structures Corp. for a swatchbook.



Woodmere Park  
Venice, FL



Fountain Apartments  
Venice, FL



Englewood Sports Complex  
Englewood, FL



Nokomis Park  
Nokomis, FL



St Mark's Church  
Venice, FL

Sarasota Growers  
Sarasota, FL



## Warranty

Sunguard Shade Structures' fabrics are warranted for 10 years against failure due to rot, UV deterioration, or faulty workmanship. ***This warranty is non-prorated.*** Steel frames are warranted for 20 years against failure due to corrosion, deterioration or faulty workmanship. This warranty does not cover vandalism, failure to provide routine maintenance, nor Acts of God. ***Cover must be removed in winds expected to exceed 75 mph. Incorrect installation voids all warranties.***

## General Notes

Units are designed for perimeter posts only. All units are clear span—no center support posts necessary. Most units require only four (4) posts, however, larger units and extra tall units may require additional perimeter posts.

Sunguard has over 600 standard sizes and shapes—all professionally engineered to meet national building codes and wind load requirements ASCE 7-02 (ASD, LRFD). If you don't see the size you are looking for, please call for a quote from our data bank. Prices are subject to change.

## Packaging & Handling

Standard packaging and handling is included in the net price listed. Additional packaging is required west of the Mississippi River, add \$60 per unit.

## Powder Coat Finishes

Sunguard proudly provides a top quality, cold-rolled, flo-coat galvanized finish as standard on all units. Customers may select one of our 10 standard powder coat colors as an alternative finish. Custom colors are available, customer must provide a swatch for matching.

Custom colors.....+10% to list price

## Terms & Conditions

Prices FOB—Sarasota, Florida

**4%**—discount when full payment is received with order.

**Net 30**—from date of invoice to all government agencies and those with approved credit.

**Note**—Accounts exceeding 30 days of invoice will be billed finance charges at the rate of 1.5% of unpaid balance with a minimum \$25 charge.

***Installation & freight are not included in the prices listed.***

## Ordering

When ordering, we **must** have six (6) essential items of information:

- 1) Model Number
- 2) Fabric Color
- 3) Steel Finish
- 4) Installation (Mounting Type)
- 5) Post Height
- 6) Most Recent Site Plan or Survey with all playground equipment noted (when requesting sealed drawings)

## Attention Designers

All squares, rectangles and triangles can be connected to expand coverage or to meet architectural requirements. Units are connected by special interconnecting posts. Calculate price by using standard unit prices of the units being connected. Please specify on the purchase order that you want interconnecting units.

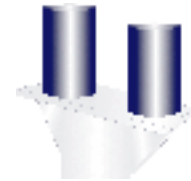

## Sealed Drawings

If a sealed drawing is required a ***site plan or survey must be included with the order, electronic format preferred.*** All existing structures, including playground equipment must be noted. Additional charges will be incurred for sealed drawings.

## Custom Applications

Sunguard Shade Structures' product designers and engineers can design units to meet most requirements. Send us a survey, a site plan or a proposal and we will be glad to give you a quote and preliminary design. We can custom design for snow loads and wind loads up to 170mph.

## Post Height

Additional post heights of 9'-12' are available, please call for a custom quote. Remember, the higher the posts, the smaller the shade pattern; use the lowest height consistent with obstacle clearance possible.

# *Price List*

**Effective August 01, 2005**



*[www.floridasunshade.com](http://www.floridasunshade.com)*

*[sales@sunguard.net](mailto:sales@sunguard.net)*

*1.800.319.1010*

*This price list supercedes all previous price changes.  
Information & pricing subject to change without notice.*

*Premier Manufacturer of Shade Structures* ● *Promoting Sun Safety & Cool Comfort*