

# *Price List*

**Effective August 01, 2005**



**Sunguard Shade Structures  
CORPORATION**

*www.floridasunshade.com*  
*sales@sunguard.net*  
*1.800.319.1010*

***Premier Manufacturer of Shade Structures***

***Promoting Sun Safety & Cool Comfort***

# Contact & Contents

Address	4487 B Ashton Rd • Sarasota FL 32433
Toll Free	1.800.319.1010
Phone	941.925.3000
Fax	941.925.3001
Web Site	www.floridasunshade.com
email	sales@sunguard.net



I personally received and opened the boxes to the shade structures and personally installed one. I just wanted to thank you personally for your efforts in getting them to me on time. I've attached a picture of the one that I assembled, it looks great and was very easy to do.

Thank You



## Florida State Contract

Contract	650-001-04-1
Toll Free	1.800.319.1010
Phone	941.925.3000
Fax	941.925.3001
Web Site	www.floridasunshade.com
email	sales@sunguard.net

	Page	Type
Contact Information	2	Information
Contents	2	Information
Why Sunguard?	3	Information
Florida State Contract	4	Information
Sun Safety	5	Information
Rectangles	8	Standard
Squares	9	Standard
Triangles	10	Standard
Hexagons	11	Standard
Octagons	12	Standard
Star-Octagons	12	Standard
BreezeBrellas	13	Umbrellas
Play Towers	14	Playground Towers
3-Row Bleacher Covers	16	Bleachers
5-Row Bleacher Covers	17	Bleachers
10-Row Bleacher Covers	18	Bleachers
T-Styles	19	Dugouts & Benches
Side Panels	20	Protection
Shade Park: Double Row	22	Cantilevers
Shade Park: Single Row	23	Cantilevers
Shadow Wing	24	Cantilevers
Super Contemporary	25	Cantilevers
Contemporary	25	Cantilevers
Custom Designs	28	Custom Units
Heating Systems	30	Accessories
Lighting Systems	30	Accessories
Logos	30	Accessories
Misting Systems	30	Accessories
Post Pads	30	Accessories
Replacement Covers	30	Accessories
Surface Mount Plates	30	Accessories
Direct Imbedment	32	Installation
Sleeve Imbedment	32	Installation
Surface (existing pad)	32	Installation
Surface (new footings)	32	Installation
Fabrics	34	Information
Frames	35	Information
Custom Applications	36	Information
General Notes	36	Information
How To Order	36	Information
Sealed Drawings	36	Information
Warranty	36	Information

### Best Quality Steel

Sunguard Shade Structures, Corp., exclusively uses **Allied Steel products**; cold-rolled, galvanized tubular steel with a triple layer of protection. Allied products outperform most steels in tensile strength and long-term corrosion resistance. In saltwater spray and other weathering tests, Allied Steel outperforms the competition.

### The Welds

Sunguard uses a special galvanized welding wire and then triple treats each weld for extra corrosion protection.

### Best Quality Fabric

Sunguard Shade Cloth fabric is known for its' great strength, vibrant colors and durability. Our covers are made from **high-density polyethylene with ultraviolet additives, using mono filament and tape construction**. Sunguard covers are *rachel knitted* which ensures fabric stability and prevents the fabric from fraying, even when cut. This special knitting also ensures a consistent shade pattern.

Technical specs:

- Fabric Burst Strength: 260 KPA
- Tear Strength: 100 KG (warp)
- 210 KG (weft)

### The Corners

Sunguard **triple reinforces all connecting points**. Each connecting point has nylon webbing sewn in the interior to further reinforce the corner. In addition, the corners are designed to conceal the tensioning cable to give clean, smooth lines.

### The Thread

Sunguard uses a Teflon (PTFE) thread from the W. L. Gore Company, which will not deteriorate in the sun. The thread carries a lifetime guarantee and will not rot due to ultraviolet exposure or other environmental causes.

### The Warranty

Sunguard Shade Structures, Corp., has the best warranty in the industry. **We warranty all steel framework for 20 years and all fabric covers for 10 years**. For further information, please see our Certificate of Warranty. **This is a non-prorated warranty.**

### Fire Safety

Sunguard fabrics pass the E-84 fire rating test as well as the NFPA-701 and are rated a Class 1 Material.

### The Cable

Sunguard uses a special galvanized cable that is UV stabilized to tension the fabric perimeter. This ensures long-term durability for the cable and the fabric.

### Ultra-Violet Protection

Sunguard is the only shade company to have its cloth **tested by an independent laboratory** to verify and certify that its cloth blocks 90% or more of the cancer causing UV radiation. All colors that pass this stringent test are indicated on our brochures.

### Engineering

Sunguards are designed to meet the toughest building codes in the world! **Sunguards are routinely engineered to meet 120 mph wind loads!** They are also designed from 140 mph to 170 mph wind-borne debris regions as specified by the American Society of Civil Engineers Standard (ASCE 7-02).



**Shade Structures**  
**Annual State Contract *Frequently Asked Questions***  
**Contract #650-001-04-1**

What products are offered on the state contract?

- Our Standard Units
  - Rectangles
  - Squares
  - Triangles
  - Hexagons
  - Octagons
  - Star-Octagons
  - Safe Fun in the Sun Shade Towers Systems™
  - BreezeBrellas™
  - Bleacher Covers
  - Dugouts/T-Styles
  - Side Panel Protectors
  - Cantilever Systems
    - Shade Park™
    - Shadow Wing™
    - Super Contemporary
    - Contemporary
- Custom Designed Units
- Our Accessories

Who can purchase from the state contract?

- County School Systems
- School Principals & Maintenance
- Parks & Recreation Departments
- Florida Agencies
- Florida Municipalities

Why should the state contract be utilized?

- It's a competitively bid contract.
- Eliminates writing specs, advertising, bid meetings & invitations.
- Ability to place orders when you need to.

How does the process work?

- Log on to the Florida State website:  
[www.myflorida.com/st\\_contracts/650001041](http://www.myflorida.com/st_contracts/650001041)
- Select the product fitting your needs or call us for assistance.
- Fax, mail or email your purchase order.

**Sunguard Shade Structures Corp.**  
**sales@sunguard.net • www.floridasunshade.com**  
**1.800.319.1010 • 941.925.3000**

*As you know, sun safety has become an integral part of play area safety for our children. Skin cancer rates are rising and the solar uv exposure to children is a leading contributor. Shade is the best preventative, and can be provided by trees, buildings, or Sunguard Shade Structure Units. Regardless of the source insist that facilities your children play at provide shade.*

## Protect Yourself from the Sun

- **Stay in the shade whenever possible.**  
The sun's rays are strongest between the hours of 10 a.m. and 4 p.m.
- **No shadow...seek the shade!**  
If your shadow is shorter than you are, you're likely to burn.
- Wear protective, tightly woven clothing, such as a long-sleeved shirt and pants.
- Apply a broad-spectrum sunscreen with a Sun Protection Factor (SPF) of at least 15.
- Reapply sunscreen every 2 hours when outdoors, even on cloudy days.
- Wear a wide-brimmed hat and sunglasses when outdoors.







*1 in 5 children will grow up to have some form of skin cancer.*

rectangles  
rectangles

squares  
squares

triangles  
triangles

hexagons  
hexagons

octagons  
octagons

shade towers  
shade towers

breezeshades  
breezeshades



# rectangles

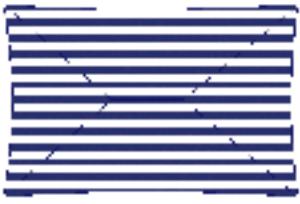

Florida House  
Sarasota, FL



Model	Size <sup>1</sup>	Area <sup>2</sup>	Peak Height <sup>3</sup>	Finish <sup>4</sup>	Weight <sup>5</sup>	Retail	State <sup>6</sup>
R1012G	10'x12'	120	9.7'	G	312	\$1,309	\$982
R1012P	10'x12'	120	9.7'	PC	312	\$1,940	\$1,455
R1016G	10'x16'	160	9.7'	G	332	\$1,535	\$1,151
R1016P	10'x16'	160	9.7'	PC	332	\$2,154	\$1,615
R1020G	10'x20'	200	10.1'	G	355	\$1,618	\$1,214
R1020P	10'x20'	200	10.1'	PC	355	\$2,440	\$1,830
R1024G	10'x24'	240	10.8'	G	380	\$2,118	\$1,589
R1024P	10'x24'	240	10.8'	PC	380	\$2,880	\$2,160
R1030G	10'x30'	300	10.8'	G	420	\$2,463	\$1,847
R1030P	10'x30'	300	10.8'	PC	420	\$3,237	\$2,428

R1810G	18'x10'	180	10.1'	G	345	\$1,618	\$1,214
R1810P	18'x10'	180	10.1'	PC	345	\$2,368	\$1,776
R1816G	18'x16'	288	10.7'	G	433	\$2,321	\$1,740
R1816P	18'x16'	288	10.7'	PC	433	\$3,082	\$2,312
R1820G	18'x20'	360	10.6'	G	470	\$2,713	\$2,035
R1820P	18'x20'	360	10.6'	PC	470	\$3,522	\$2,642
R1824G	18'x24'	432	10.6'	G	495	\$3,058	\$2,294
R1824P	18'x24'	432	10.6'	PC	495	\$3,891	\$2,918
R1826G	18'x26'	468	10.6'	G	510	\$3,320	\$2,490
R1826P	18'x26'	468	10.6'	PC	510	\$4,177	\$3,133
R1830G	18'x30'	540	11.2'	G	615	\$3,737	\$2,802
R1830P	18'x30'	540	11.2'	PC	615	\$4,736	\$3,552
R1832G	18'x32'	576	11.2'	G	630	\$3,987	\$2,990
R1832P	18'x32'	576	11.2'	PC	630	\$4,962	\$3,722
R1840G	18'x40'	720	11.2'	G	730	\$4,986	\$3,740
R1840P	18'x40'	720	11.2'	PC	730	\$6,140	\$4,605

Model	Size <sup>1</sup>	Area <sup>2</sup>	Peak Height <sup>3</sup>	Finish <sup>4</sup>	Weight <sup>5</sup>	Retail	State <sup>6</sup>
R2012G	20'x12'	240	10.4'	G	375	\$1,940	\$1,455
R2012P	20'x12'	240	10.4'	PC	375	\$2,654	\$1,990
R2015G	20'x15'	300	10.4'	G	396	\$2,213	\$1,660
R2015P	20'x15'	300	10.4'	PC	396	\$2,963	\$2,222
R2016G	20'x16'	320	10.7'	G	450	\$2,297	\$1,723
R2016P	20'x16'	320	10.7'	PC	450	\$3,237	\$2,428
R2022G	20'x22'	440	10.9'	G	505	\$3,118	\$2,338
R2022P	20'x22'	440	10.9'	PC	505	\$3,951	\$2,963
R2024G	20'x24'	480	10.9'	G	520	\$3,296	\$2,472
R2024P	20'x24'	480	10.9'	PC	520	\$4,177	\$3,133
R2028G	20'x28'	560	10.9'	G	602	\$3,868	\$2,901
R2028P	20'x28'	560	10.9'	PC	602	\$4,784	\$3,588
R2030G	20'x30'	600	11'	G	620	\$4,367	\$3,275
R2030P	20'x30'	600	11'	PC	620	\$5,379	\$4,034
R2040G	20'x40'	800	11.5'	G	750	\$5,415	\$4,061
R2040P	20'x40'	800	11.5'	PC	750	\$6,616	\$4,962

R3032G	30'x32'	960	12.4'	G	775	\$6,188	\$4,641
R3032P	30'x32'	960	12.4'	PC	775	\$7,402	\$5,551
R3034G	30'x34'	1020	12.4'	G	810	\$6,462	\$4,846
R3034P	30'x34'	1020	12.4'	PC	810	\$7,711	\$5,783
R3036G	30'x36'	1080	12.4'	G	830	\$6,735	\$5,052
R3036P	30'x36'	1080	12.4'	PC	830	\$8,056	\$6,042
R3040G	30'x40'	1200	12.4'	G	870	\$7,330	\$5,498
R3040P	30'x40'	1200	12.4'	PC	870	\$8,628	\$6,471

R4050G <sup>†</sup>	40'x50'	2000	13.5'	G	2130	\$13,090	\$9,818
R4050P <sup>†</sup>	40'x50'	2000	13.5'	PC	2130	\$15,232	\$11,424
R5060G <sup>‡</sup>	50'x60'	3000	14.8'	G	3110	\$21,872	\$16,404
R5060P <sup>‡</sup>	50'x60'	3000	14.8'	PC	3110	\$27,013	\$20,260

<sup>1</sup> Length x Width x Height (8' column)
<sup>2</sup> Square Foot
<sup>3</sup> Peak Height with (an 8' Column height)
<sup>4</sup> G (Galvanized); PC (Powder Coat)
<sup>5</sup> Approximate Shipping Weight (lbs).
<sup>6</sup> Florida State Discount of 25%.
<sup>†</sup> Denotes 6 or more columns are required.
<sup>‡</sup> Denotes 8 or more columns are required.

**Prices are for Direct Imbedment only.**  
Surface Mount Plates are \$54 each at Florida State Discount.



Model	Size <sup>1</sup>	Area <sup>2</sup>	Peak Height <sup>3</sup>	Finish <sup>4</sup>	Weight <sup>5</sup>	Retail	State <sup>6</sup>
S1010G	10'x10'	100	9.6'	G	310	\$1,214	\$910
S1010P	10'x10'	100	9.6'	PC	310	\$1,809	\$1,357
S1212G	12'x12'	144	9.9'	G	325	\$1,440	\$1,080
S1212P	12'x12'	144	9.9'	PC	325	\$2,094	\$1,571
S1515G	15'x15'	225	10.3'	G	360	\$1,868	\$1,401
S1515P	15'x15'	225	10.3'	PC	360	\$2,564	\$1,946
S1616G	16'x16'	256	10.5'	G	425	\$2,154	\$1,615
S1616P	16'x16'	256	10.5'	PC	425	\$2,892	\$2,169
S1818G	18'x18'	324	10.5'	G	460	\$2,535	\$1,901
S1818P	18'x18'	324	10.5'	PC	460	\$3,308	\$2,481
S2020G	20'x20'	400	10.8'	G	490	\$2,916	\$2,187
S2020P	20'x20'	400	10.8'	PC	490	\$3,737	\$2,802
S2222G	22'x22'	484	11.1'	G	590	\$3,534	\$2,651
S2222P	22'x22'	484	11.1'	PC	590	\$4,391	\$3,293
S2424G	24'x24'	576	11.4'	G	620	\$3,951	\$2,963
S2424P	24'x24'	576	11.4'	PC	620	\$4,962	\$3,722
S2525G	25'x25'	625	11.4'	G	640	\$4,236	\$3,177
S2525P	25'x25'	625	11.4'	PC	640	\$5,177	\$3,882
S2626G	26'x26'	676	11.7'	G	660	\$4,474	\$3,356
S2626P	26'x26'	676	11.7'	PC	660	\$5,486	\$4,114
S2828G	28'x28'	784	12.0'	G	700	\$5,046	\$3,784
S2828P	28'x28'	784	12.0'	PC	700	\$6,117	\$4,587
S3030G	30'x30'	900	12.3'	G	770	\$5,902	\$4,427
S3030P	30'x30'	900	12.3'	PC	770	\$7,116	\$5,337
S4040G†	40'x40'	1600	13.8'	G	1,530	\$9,984	\$7,488
S4040P†	40'x40'	1600	13.8'	PC	1,530	\$11,424	\$8,568
S5050G‡	50'x50'	2500	14.1'	G	2,485	\$15,625	\$11,719
S5050P‡	50'x50'	2500	14.1'	PC	2,485	\$18,124	\$13,593



squares



Forty Carrots Pre-school  
Sarasota, FL

<sup>1</sup> Length x Width x Height (8' column)
<sup>2</sup> Square Foot
<sup>3</sup> Peak Height with (an 8' Column height)
<sup>4</sup> G (Galvanized); PC (Powder Coat)
<sup>5</sup> Approximate Shipping Weight (lbs).
<sup>6</sup> Florida State Discount of 25%.
<sup>†</sup> Denotes 6 or more columns are required.
<sup>‡</sup> Denotes 8 or more columns are required.

<b>Prices are for Direct Imbedment only.</b>
Surface Mount Plates are \$54 each at Florida State Discount.

# triangles



Child Development Center  
Federal Building  
Honolulu, HI



Cove Creek Park  
Cove Creek, VA

Model	Size <sup>1</sup>	Area <sup>2</sup>	Peak Height <sup>3</sup>	Finish <sup>4</sup>	Weight <sup>5</sup>	Retail	State <sup>6</sup>
T10G	10'x8'	43	9.3'	G	200	\$726	\$544
T10P	10'x8'	43	9.3'	PC	200	\$1,119	\$839

T12G	12'x8'	62	10.0'	G	240	\$833	\$625
T12P	12'x8'	62	10.0'	PC	240	\$1,309	\$982

T14G	14'x8'	85	10.3'	G	245	\$964	\$723
T14P	14'x8'	85	10.3'	PC	245	\$1,440	\$1,080

T16G	16'x8'	110	10.7'	G	295	\$1,226	\$919
T16P	16'x8'	110	10.7'	PC	295	\$1,726	\$1,294

T18G	18'x8'	140	10.4'	G	320	\$1,369	\$1,026
T18P	18'x8'	140	10.4'	PC	320	\$1,940	\$1,455

T20G	20'x8'	173	10.7'	G	380	\$1,559	\$1,169
T20P	20'x8'	173	10.7'	PC	380	\$2,118	\$1,589

T22G	22'x8'	209	11.0'	G	410	\$1,809	\$1,357
T22P	22'x8'	209	11.0'	PC	410	\$2,428	\$1,821

T23G	23'x8'	229	11.1'	G	450	\$1,940	\$1,455
T23P	23'x8'	229	11.1'	PC	450	\$2,570	\$1,928

T24G	24'x8'	249	11.3'	G	490	\$2,023	\$1,517
T24P	24'x8'	249	11.3'	PC	490	\$2,666	\$1,999

T25G	25'x8'	270	11.4'	G	510	\$2,166	\$1,624
T25P	25'x8'	270	11.4'	PC	510	\$2,808	\$2,106

T26G	26'x8'	292	11.5'	G	525	\$2,309	\$1,731
T26P	26'x8'	292	11.5'	PC	525	\$2,951	\$2,213

T28G	28'x8'	339	11.8'	G	575	\$2,737	\$2,053
T28P	28'x8'	339	11.8'	PC	575	\$3,606	\$2,704

T30G	30'x8'	389	12.1'	G	650	\$3,035	\$2,276
T30P	30'x8'	389	12.1'	PC	650	\$3,891	\$2,918

<sup>1</sup>Length x Width x Height (8' column)

<sup>2</sup>Square Foot

<sup>3</sup>Peak Height with (an 8' Column height)

<sup>4</sup>G (Galvanized); PC (Powder Coat)

<sup>5</sup>Approximate Shipping Weight (lbs).

<sup>6</sup>Florida State Discount of 25%.

**Prices are for Direct Imbedment only.**

Surface Mount Plates are \$54 each at Florida State Discount.

Model	Size <sup>1</sup>	Area <sup>2</sup>	Peak Height <sup>3</sup>	Finish <sup>4</sup>	Weight <sup>5</sup>	Retail	State <sup>6</sup>
H16G	16'	166	10.3'	G	480	\$2,130	\$1,598
H16P	16'	166	10.3'	PC	480	\$3,130	\$2,347
H18G	18'	210	10.6'	G	520	\$2,868	\$2,151
H18P	18'	210	10.6'	PC	520	\$3,499	\$2,624

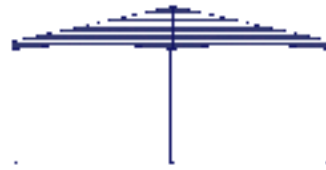

hexagons

H20G	20'	260	10.3'	G	615	\$2,892	\$2,169
H20P	20'	260	10.3'	PC	615	\$3,975	\$2,981
H24G	24'	374	10.8'	G	710	\$3,749	\$2,811
H24P	24'	374	10.8'	PC	710	\$4,927	\$3,695
H26G	26'	439	11.1'	G	770	\$4,236	\$3,177
H26P	26'	439	11.1'	PC	770	\$5,462	\$4,097

H30G	30'	585	11.5'	G	880	\$5,248	\$3,936
H30P	30'	585	11.5'	PC	880	\$6,569	\$4,927
H36G	36'	842	12.2'	G	1,100	\$7,176	\$5,382
H36P	36'	842	12.2'	PC	1,100	\$8,699	\$6,524

H40G	40'	1039	12.7'	G	1,240	\$8,497	\$6,372
H40P	40'	1039	12.7'	PC	1,240	\$10,127	\$7,595
H45G	45'	1316	13.3'	G	1,430	\$10,341	\$7,756
H45P	45'	1316	13.3'	PC	1,430	\$12,126	\$9,095

<sup>1</sup> Length x Width x Height (8' column)
<sup>2</sup> Square Foot
<sup>3</sup> Peak Height with (an 8' Column height)
<sup>4</sup> G (Galvanized); PC (Powder Coat)
<sup>5</sup> Approximate Shipping Weight (lbs).
<sup>6</sup> Florida State Discount of 25%.
<b>Prices are for Direct Imbedment only.</b>
Surface Mount Plates are \$54 each at Florida State Discount.



Orla Vista Park  
Orlando, FL

# octagons

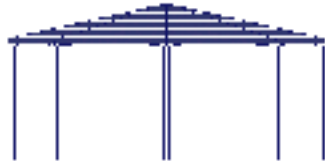

Cove Creek Park  
Faber, VA

Model	Size <sup>1</sup>	Area <sup>2</sup>	Peak Height <sup>3</sup>	Finish <sup>4</sup>	Weight <sup>5</sup>	Retail	State <sup>5</sup>
O40G	40'	1132	13.9'	G	1,510	\$9,853	\$7,390
O40P	40'	1132	13.9'	PC	1,510	\$12,019	\$9,014
O45G	45'	1433	14.6'	G	1,815	\$11,900	\$8,925
O45P	45'	1433	14.6'	PC	1,815	\$14,244	\$10,683

O50G	50'	1770	15.4'	G	2,330	\$15,815	\$11,861
O50P	50'	1770	15.4'	PC	2,330	\$18,683	\$14,012
O55G	55'	2142	16.1'	G	2,610	\$18,397	\$13,798
O55P	55'	2142	16.1'	PC	2,610	\$21,242	\$15,931

O60G	60'	2549	16.8'	G	2,960	\$21,123	\$15,842
O60P	60'	2549	16.8'	PC	2,960	\$24,371	\$18,278

<sup>1</sup>Length x Width x Height (8' column)

<sup>2</sup>Square Foot

<sup>3</sup>Peak Height with (an 8' Column height)

<sup>4</sup>G (Galvanized); PC (Powder Coat)

<sup>5</sup>Approximate Shipping Weight (lbs).

<sup>6</sup>Florida State Discount of 25%.

**Prices are for Direct Imbedment only.**

Surface Mount Plates are \$54 each at Florida State Discount.

# star-octagons



Cannon Air Force Base  
New Mexico



Model	Size <sup>1</sup>	Area <sup>2</sup>	Peak Height <sup>3</sup>	Finish <sup>4</sup>	Weight <sup>5</sup>	Retail	State <sup>6</sup>
S065G	65'	2991	17.6'	G	2,991	\$32,130	\$24,098
S065P	65'	2991	17.6'	PC	2,991	\$38,199	\$28,649

S070G	70'	3470	18.3'	G	3,470	\$36,236	\$27,177
S070P	70'	3470	18.3'	PC	3,470	\$42,840	\$32,130
S075G	75'	3982	19.1'	G	3,982	\$44,363	\$33,272
S075P	75'	3982	19.1'	PC	3,982	\$47,481	\$35,611

<sup>1</sup>Length x Width x Height (8' column)

<sup>2</sup>Square Foot

<sup>3</sup>Peak Height with (an 8' Column height)

<sup>4</sup>G (Galvanized); PC (Powder Coat)

<sup>5</sup>Approximate Shipping Weight (lbs).

<sup>6</sup>Florida State Discount of 25%.

**Prices are for Direct Imbedment only.**

Surface Mount Plates are \$54 each at Florida State Discount.



Model	Diameter <sup>1</sup>	Finish <sup>2</sup>	Weight <sup>3</sup>	Retail	State <sup>4</sup>
U12P	12'	PC	350	\$2,047	\$1,535
U13P	13'	PC	350	\$2,047	\$1,535
U14P	14'	PC	350	\$2,047	\$1,535
U15P	15'	PC	350	\$2,047	\$1,535
U16P	16'	PC	350	\$2,047	\$1,535
U17P	17'	PC	400	\$3,142	\$2,356
U18P	18'	PC	400	\$3,142	\$2,356
U16P	19'	PC	400	\$3,142	\$2,356
U20P	20'	PC	400	\$3,142	\$2,356



**breezebrellas**

<sup>1</sup>Diameter of 12' to 20' with Eave Heights of 7' to 10' are available.  
<sup>2</sup>BreezeBrella™ units are available in Powder Coat finish only.  
<sup>3</sup>Approximate Shipping Weight (lbs).  
<sup>4</sup>Florida State Discount of 25%.  
 BreezeBrella™ units are available with Sleeve Imbedment only.  
 Please refer to the Mounting Section of this guide for specifications.

# *BreezeBrellas*

Greenwood Recreation Center  
 Clearwater, FL



play towers



Model #	Size <sup>1</sup>	Pitch <sup>2</sup>	Finish <sup>3</sup>	Weight <sup>4</sup>	Retail	State <sup>5</sup>
ST1515G	15' x 15' x 8'	30°	G	360	\$1,541	\$1,156
ST1515P	15' x 15' x 8'	30°	PC	360	\$2,142	\$1,607

ST2020G	20' x 20' x 8'	16°	G	490	\$2,404	\$1,803
ST2020P	20' x 20' x 8'	16°	PC	490	\$3,094	\$2,321
ST2525G	25' x 25' x 8'	16°	G	640	\$3,511	\$2,633
ST2525P	25' x 25' x 8'	16°	PC	640	\$4,284	\$3,213

<sup>1</sup> Length x Width x Height (8' column)
<sup>2</sup> Pitch is given in degrees.
<sup>3</sup> G (Galvanized); PC (Powder Coat)
<sup>4</sup> Approximate Shipping Weight (lbs).
<sup>5</sup> Florida State Discount of 25%.
<b>Prices are for Direct Imbedment only.</b>

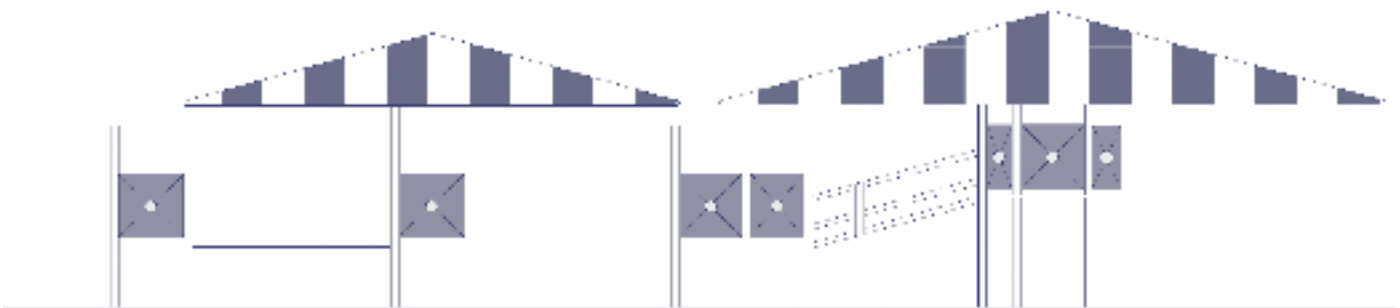
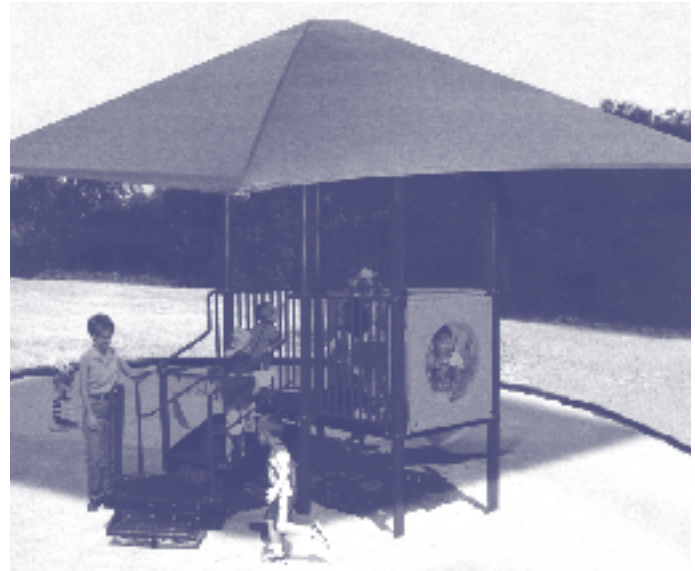

3 row covers

5 row covers

10 row covers

t-styles

side panels



# 3 row bleachers

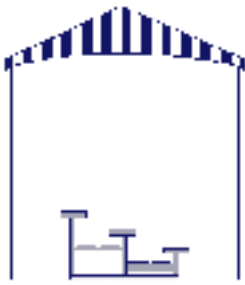

Bleacher Size		Cover Recommendation				
Length	Capacity	Model #	Unit Size <sup>1</sup>	Weight <sup>2</sup>	Retail	State <sup>3</sup>
15'	30	B1810G	18'x10'x8'	345	\$1,618	\$1,214
21'	42	B2410G	24'x10'x8'	378	\$2,118	\$1,589
27'	54	B3010G	30'x10'x8'	414	\$2,463	\$1,847

<sup>1</sup>All dimensions are listed Length x Width x Height (column)  
<sup>2</sup>Approximate Shipping Weight (lbs).  
<sup>3</sup>Florida State Discount of 25%.  
 Bleacher Unit prices are for Galvanized finish only. Powder coating available upon request.  
**Prices are for Direct Imbedment only.**  
 Surface Mount Plates are \$54 each at Florida State Discount.

Cal Ripken Little League Complex  
Sarasota, FL

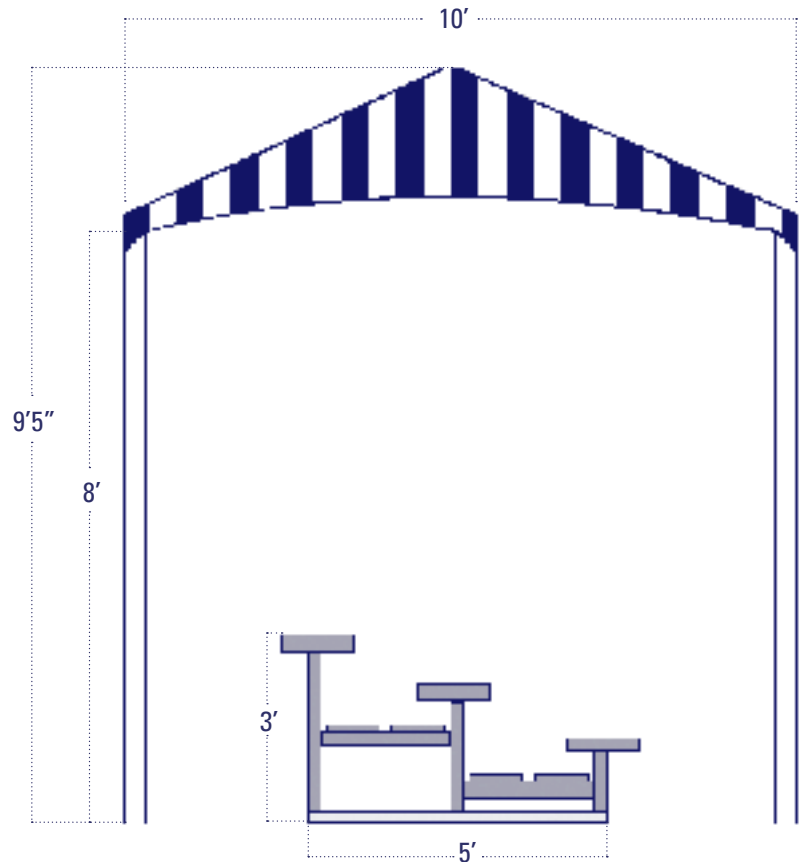



Bleacher Size		Cover Recommendation				
Length	Capacity	Model #	Unit Size <sup>1</sup>	Weight <sup>2</sup>	Retail	State <sup>3</sup>
15'	50	B1812G	18'x12'x9'	355	\$1,964	\$1,473
21'	70	B2412G	24'x12'x9'	410	\$2,440	\$1,830
27'	90	B3012G	30'x12'x9'	500	\$2,832	\$2,124

<sup>1</sup>All dimensions are listed Length x Width x Height (column)

<sup>2</sup>Approximate Shipping Weight (lbs).

<sup>3</sup>Florida State Discount of 25%.

Bleacher Unit prices are for Galvanized finish only. Powder coating available upon request.

**Prices are for Direct Imbedment only.**

Surface Mount Plates are \$54 each at Florida State Discount.

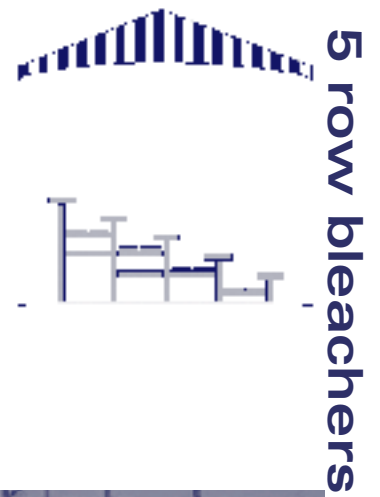

Braden River Little League  
Bradenton, FL

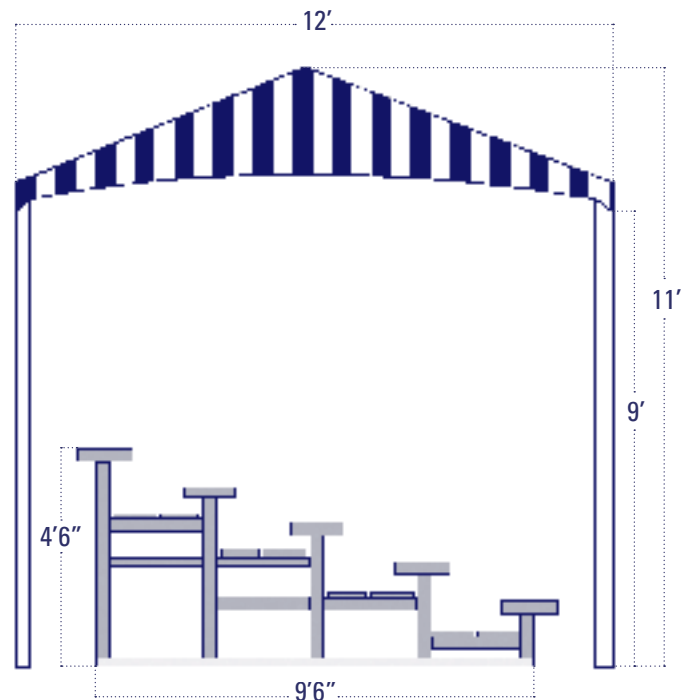

Cal Ripken Little League Complex  
Sarasota, FL

# 10 row bleachers



Bleacher Size		Cover Recommendation				
Length	Capacity	Model #	Unit Size <sup>1</sup>	Weight <sup>2</sup>	Retail	State <sup>3</sup>
15'	100	B2218G	18'x22'x12'	480	\$3,927	\$2,945
21'	140	B2422G	24'x22'x12'	528	\$4,879	\$3,659
27'	180	B3022G	30'x22'x12'	651	\$5,653	\$4,239

<sup>1</sup>All dimensions are listed Length x Width x Height (column)

<sup>2</sup>Approximate Shipping Weight (lbs).

<sup>3</sup>Florida State Discount of 25%.

Bleacher Unit prices are for Galvanized finish only. Powder coating available upon request.

**Prices are for Direct Imbedment only.**

Surface Mount Plates are \$54 each at Florida State Discount.



Sarasota Redskins Football Complex



Cal Ripken Little League Complex  
FL

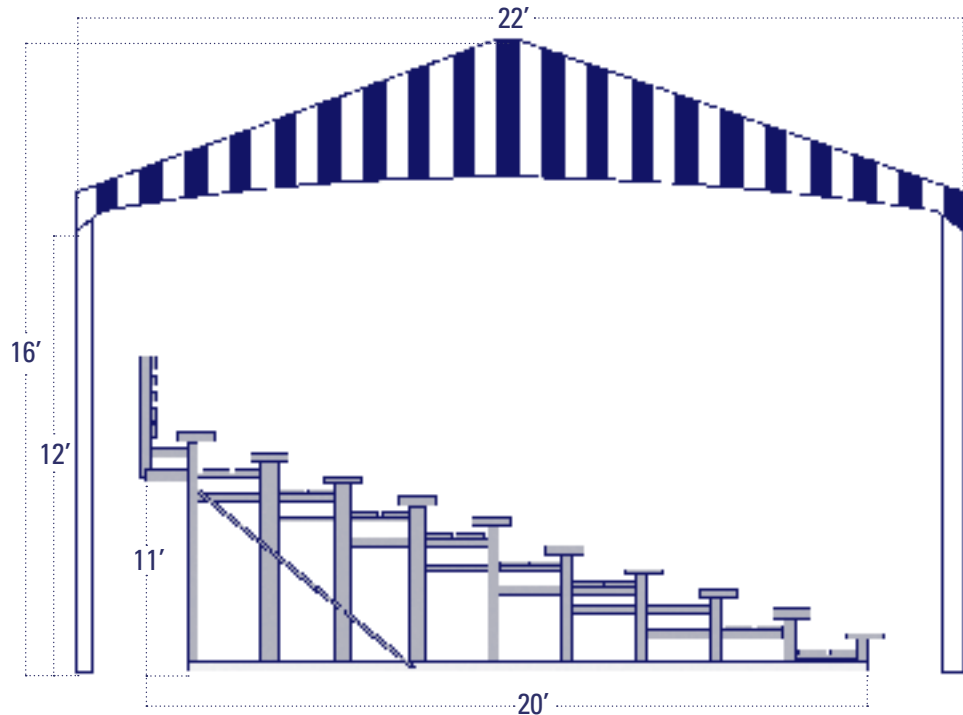

Model #	Unit Size <sup>1</sup>	Finish <sup>2</sup>	Weight <sup>3</sup>	Retail	State <sup>4</sup>
D1012G	10'x12'x8'	G	232	\$1,309	\$982
D1012P	10'x12'x8'	PC	232	\$1,535	\$1,151
D1016G	10'x16'x8'	G	260	\$1,452	\$1,089
D1016P	10'x16'x8'	PC	260	\$1,690	\$1,267
D1018G	10'x18'x8'	G	275	\$1,642	\$1,232
D1018P	10'x18'x8'	PC	275	\$1,892	\$1,419
D1020G	10'x20'x8'	G	295	\$1,714	\$1,285
D1020P	10'x20'x8'	P	295	\$1,964	\$1,473

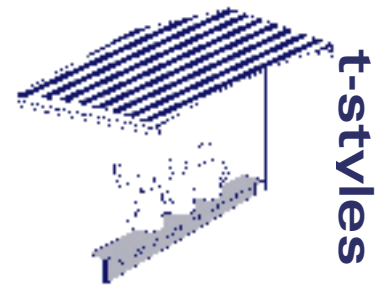

<sup>1</sup> Length x Width x Height (8' column)
<sup>2</sup> G (Galvanized); PC (Powder Coat)
<sup>3</sup> Approximate Shipping Weight (lbs).
<sup>4</sup> Florida State Discount of 25%.
<b>Prices are for Direct Imbedment only.</b>
Surface Mount Plates are \$54 each at Florida State Discount.



Ashton Elementary School  
Sarasota, FL



Fruitville Public Library Butterfly Garden  
Sarasota, FL



Automation Car Wash  
Houston, TX



side panels



Description	Retail	State <sup>1</sup>
3' Back Drop w/ grommets placed per customer specification	\$5 sq ft	\$4 sq ft

<sup>1</sup>Florida State Discount of 25%.

Protect the fans with our foul ball panel protectors. Side protection is provided by fabric protectors, which are suspended between any two posts using vinyl clad, galvanized steel cables and mounting hardware. Sports fans under Sunguard Shade structures can enjoy protection too!



St. Anne's School  
Charlottesville, VA



Grove City Parks & Recreation  
Grove City, OH





shade park  
double row  
shade park double row

shade park  
single row  
shade park single row

shadow wing  
shadow wing

super  
contemporary  
super  
contemporary

contemporary  
contemporary

shade park: double row

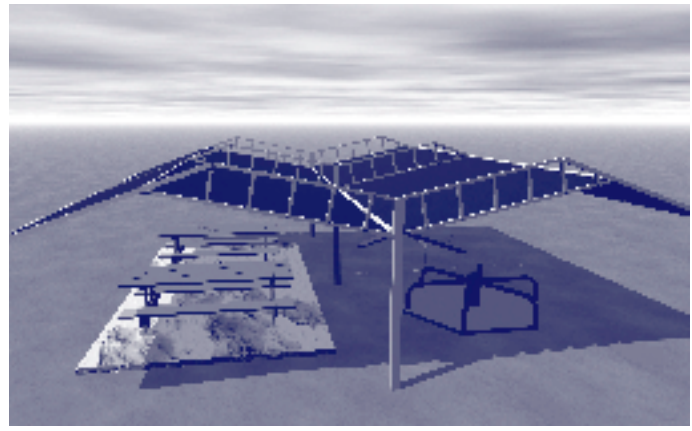

Park/Playground Equipment  
Conceptual Rendering

Lengths of 18' to 20'

Projections of 34' to 40'

Type <sup>1</sup>	Model #	Length	Projection	Height <sup>2</sup>	Finish	Weight <sup>3</sup>	Retail	State <sup>4</sup>
Master	SP1820DMP	18' to 20'	34' to 40'	7'7" to 8'	Powder Coat	1,723	\$10,157	\$7,617
Add On	SW1820DAP	18' to 20'	34' to 40'	7'7" to 8'	Powder Coat	1,130	\$6,480	\$4,860
Master	SP1820DMG	18' to 20'	34' to 40'	7'7" to 8'	Galvanized	1,723	\$8,128	\$6,096
Add On	SW1820DAG	18' to 20'	34' to 40'	7'7" to 8'	Galvanized	1,130	\$5,177	\$3,882

Lengths of 21' to 23'

Projections of 34' to 40'

Type <sup>1</sup>	Model #	Length	Projection	Height <sup>2</sup>	Finish	Weight <sup>3</sup>	Retail	State <sup>4</sup>
Master	SP2120DMP	21' to 23'	34' to 40'	7'7" to 8'	Powder Coat	1,723	\$11,299	\$8,474
Add On	SP2120DAP	21' to 23'	34' to 40'	7'7" to 8'	Powder Coat	1,130	\$7,200	\$5,400
Master	SP2120DMG	21' to 23'	34' to 40'	7'7" to 8'	Galvanized	1,723	\$9,038	\$6,779
Add On	SP2120DAG	21' to 23'	34' to 40'	7'7" to 8'	Galvanized	1,130	\$5,760	\$4,320

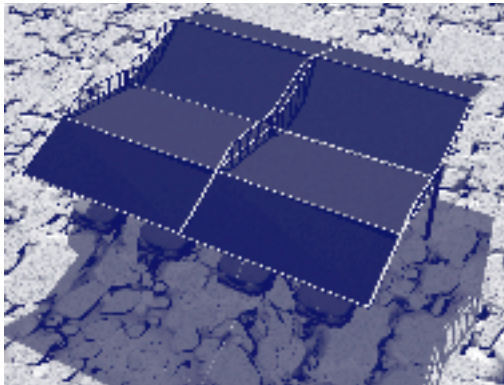

Conceptual Rendering  
Top View

<sup>1</sup> Unit Type
<sup>2</sup> Standard entry heights of 7'7" to 9' are available
<sup>3</sup> Approximate Shipping Weight (lbs).
<sup>4</sup> Florida State Discount of 25%.

<b>Footing Specifications for surface mounting with New Footing</b>
Depth of 4'x3'x2'; Re-bar (each way): 7-#5; A 307 Anchor Bolts 1"x1' with leveling nuts
<b>Prices include surface mount plates.</b>
Additional layout fee may be required depending upon the size of the project.

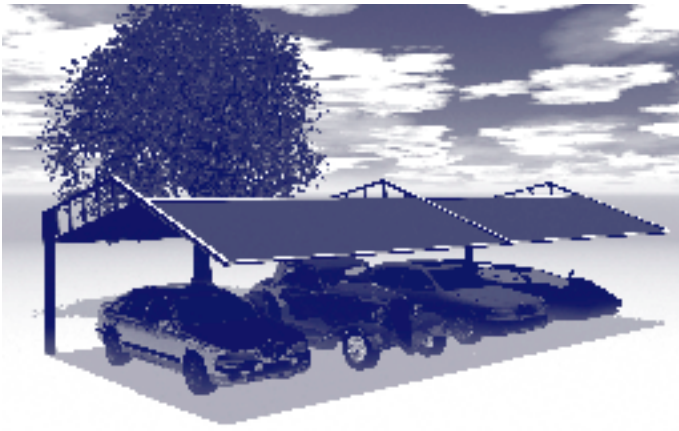

Conceptual Rendering



shade park: single row

### Lengths of 18' to 20'

### Projections of 17' to 20'

Type <sup>1</sup>	Model #	Length	Projection	Height <sup>2</sup>	Finish	Weight <sup>3</sup>	Retail	State <sup>4</sup>
Master	SP1820SMP	18' to 20'	17' to 20'	7'7" to 8'	Powder Coat	1,066	\$5,355	\$4,016
Add On	SP1820SAP	18' to 20'	17' to 20'	7'7" to 8'	Powder Coat	670	\$4,522	\$3,392
Master	SP1820SMG	18' to 20'	17' to 20'	7'7" to 8'	Galvanized	1,066	\$4,284	\$3,213
Add On	SP1820SAG	18' to 20'	17' to 20'	7'7" to 8'	Galvanized	670	\$3,624	\$2,718

### Lengths of 21' to 23'

### Projections of 17' to 20'

Type <sup>1</sup>	Model #	Length	Projection	Height <sup>2</sup>	Finish	Weight <sup>3</sup>	Retail	State <sup>4</sup>
Master	SP2123SMP	21' to 23'	17' to 20'	7'7" to 8'	Powder Coat	1,066	\$6,010	\$4,507
Add On	SP2123SAP	21' to 23'	17' to 20'	7'7" to 8'	Powder Coat	670	\$5,040	\$3,780
Master	SP2123SMG	21' to 23'	17' to 20'	7'7" to 8'	Galvanized	1,066	\$4,790	\$3,592
Add On	SP2123SAG	21' to 23'	17' to 20'	7'7" to 8'	Galvanized	670	\$4,034	\$3,026

<sup>1</sup>Unit Type

<sup>2</sup>Standard entry heights of 7'7" to 9' are available

<sup>3</sup>Approximate Shipping Weight (lbs).

<sup>4</sup>Florida State Discount of 25%.

#### Footing Specifications for surface mounting with New Footing

Depth of 4'x3'x2'; Re-bar (each way): 7-#5; A 307 Anchor Bolts 1"x1' with leveling nuts

**Prices include surface mount plates.**

Additional layout fee may be required depending upon the size of the project.

Woodland Baptist Child Center  
Bradenton, FL



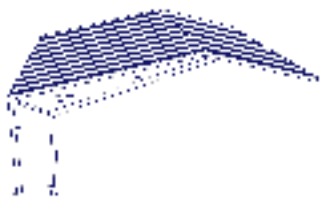

SHADOW WING



Sunguard Shade Structures  
Sarasota, FL

**Lengths of 18' to 20'**

**Projections of 16' to 20'**

Type <sup>1</sup>	Model #	Length	Projection	Area <sup>2</sup>	Finish	Weight <sup>3</sup>	Retail	State <sup>4</sup>
Master	SW1820MP	18' to 20'	16' to 20'	288' to 463'	Powder Coat	675	\$4,510	\$3,383
Add On	SW1820AP	18' to 20'	16' to 20'	288' to 463'	Powder Coat	465	\$3,451	\$2,588
Master	SW1820MG	18' to 20'	16' to 20'	288' to 463'	Galvanized	675	\$3,558	\$2,669
Add On	SW1820AG	18' to 20'	16' to 20'	288' to 463'	Galvanized	465	\$2,856	\$2,142

**Lengths of 21' to 23'**

**Projections of 16' to 20'**

Type <sup>1</sup>	Model #	Length	Projection	Area <sup>2</sup>	Finish	Weight <sup>3</sup>	Retail	State <sup>4</sup>
Master	SW2120MP	21' to 23'	16' to 20'	288' to 463'	Powder Coat	675	\$4,980	\$3,735
Add On	SW2120AP	21' to 23'	16' to 20'	288' to 463'	Powder Coat	465	\$3,749	\$2,811
Master	SW2120MG	21' to 23'	16' to 20'	288' to 463'	Galvanized	675	\$3,969	\$2,976
Add On	SW2120AG	21' to 23'	16' to 20'	288' to 463'	Galvanized	465	\$3,094	\$2,321



Sunguard Shade Structures  
Sarasota, FL

<sup>1</sup> Unit Type
<sup>2</sup> Area (sq ft)
<sup>3</sup> Approximate Shipping Weight (lbs).
<sup>4</sup> Florida State Discount of 25%.

<b>Footing Specifications for surface mounting</b>
Depth of 4'x3'x18"; Re-bar (each way): 5-#5; Wedge Anchor (Red Head) True Bolt 5/8"x8 1/2" N; Epoxy Bond: Epcor Ramset R-6 (or equivalent); Existing concrete slab: 4" (minimum).
<b>Sizing Specifications for surface mounting</b>
Lengths of 18'-20'; widths of 16'-20'; Square Footage of 288'-463'; Front Heights of 7'7"-8" and Rear Heights of 7'2"-8'2".
<b>Prices include surface mount plates.</b>
Additional layout fee may be required depending upon the size of the project.



Type <sup>1</sup>	Model #	Size <sup>2</sup>	Finish	Weight <sup>3</sup>	Retail	State <sup>4</sup>
Master	SCC2020MP	20'x20'	Powder Coat	925	\$6,069	\$4,552
Add On	SCC2020AP	20'x20'	Powder Coat	925	\$3,998	\$2,999
Master	SCC2020MG	20'x20'	Galvanized	925	\$4,498	\$3,374
Add On	SCC2020AG	20'x20'	Galvanized	925	\$2,880	\$2,160



super contemporary

<sup>1</sup> Unit Type
<sup>2</sup> All dimensions given are Length x Projection. <b>Available heights are 7' to 10'.</b> <i>Note: As the height increases in our structures, the wind loads also increase, requiring stronger specifications. Super Contemporaries are available in 20'x20', 18'x18' and 18'x20', price on request.</i>
<sup>3</sup> Approximate Shipping Weight (lbs); subject to change.
<sup>4</sup> Florida State Discount of 25%.
All Super Contemporary Units are Surface Mount only.
Additional layout fee may be required depending upon the size of the project.

## super contemporary

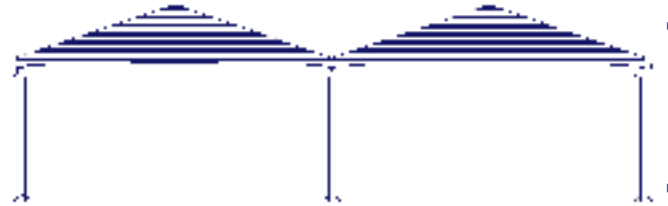

Pohick Golf Course  
Virginia

Type <sup>1</sup>	Model #	Size <sup>3</sup>	Finish	Weight <sup>4</sup>	Retail	State <sup>5</sup>
Master <sup>2</sup>	CC2040MP	40'x20'x7'	Powder Coat	1,230	\$9,377	\$7,033
Add On	CC2040AP	40'x20'x7'	Powder Coat	1,130	\$6,997	\$5,248
Master <sup>2</sup>	CC2040MG	40'x20'x7'	Galvanized	1,230	\$6,747	\$5,060
Add On	CC2040AG	40'x20'x7'	Galvanized	1,130	\$5,129	\$3,847



contemporary

<sup>1</sup> Unit Type
<sup>2</sup> Master Units are available in 40'x20' due to height.
<sup>3</sup> All dimensions given are Length x Projection x Height ( <b>max. of 7'</b> ).
<sup>4</sup> Approximate Shipping Weight (lbs).
<sup>5</sup> Florida State Discount of 25%.
All Contemporary Units are Surface Mount only.
Additional layout fee may be required depending upon the size of the project.

## contemporary



Grand Lakes Resort  
Ritz-Marriott  
Orlando, FL



Grand Lakes Resort  
Orlando, FL

Tuttle Elementary School  
Sarasota, FL



**custom  
designs**

**custom designs**

**custom  
designs**

**custom designs**



Bee Ridge Park  
Sarasota, FL



Type <sup>1</sup>	Model #	Length	Projection	Height <sup>2</sup>	Finish	Weight <sup>3</sup>	Retail <sup>4</sup>	State <sup>5</sup>
Custom	CSXXXXG	varies	varies	varies	Galvanized	varies	\$9	\$7
Custom	CSXXXXP	varies	varies	varies	Powder Coat	varies	\$10	\$8



<sup>1</sup>Unit Type

<sup>2</sup>Standard entry heights of 7'7" to 9' are available on all units unless otherwise specified.

<sup>3</sup>Shipping Weight (lbs) will vary depending upon the design specifications.

<sup>4</sup>Retail prices are per square foot.

<sup>5</sup>Florida State Discount of 25% and are listed per square foot.

East Cobb Baseball  
Cobb County, GA



Farmer's Market  
Sarasota, FL

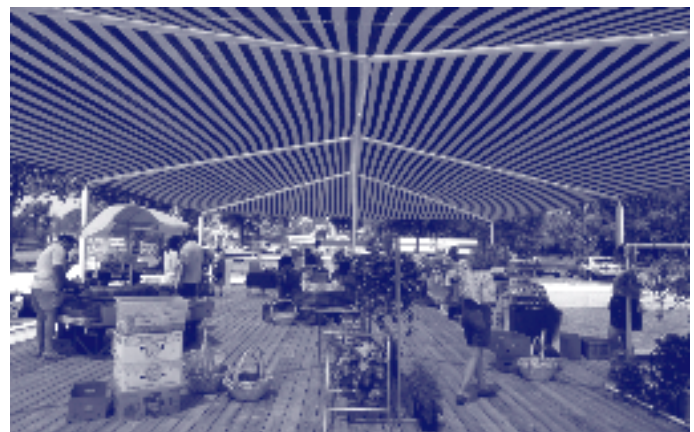



posts  
pads  
post pads

replacement  
covers  
replacement covers

logos heating  
mistings  
logos misting heating-lighting

surface  
mount plates  
surface mount plates

Post Pads

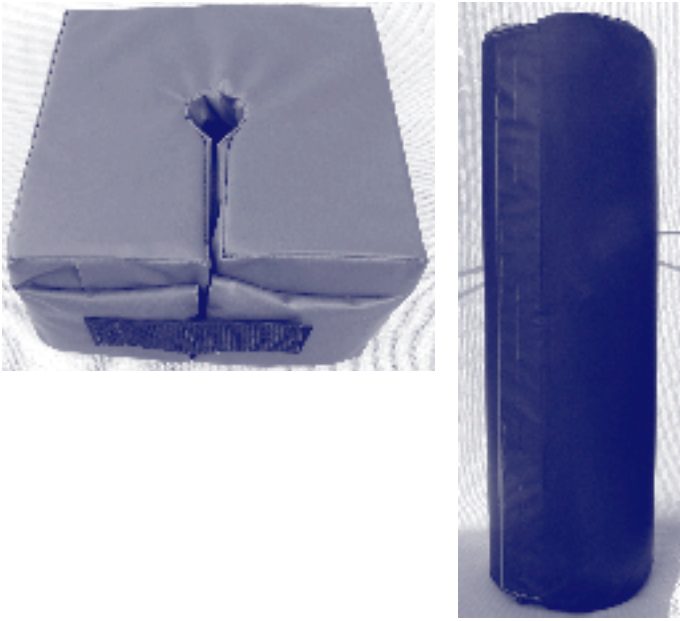

Item #	Sizes	Retail & State
Post Pads	call style sizes	varies depending upon style, call for quote

Replacement Covers

Replacement Cover Only		
Item #	Retail	State <sup>1</sup>
RC <sup>3</sup>	\$4	\$3

Replacement Cover with Cable & Clamps		
Item #	Retail	State <sup>1</sup>
RCC <sup>3</sup>	\$5	\$4

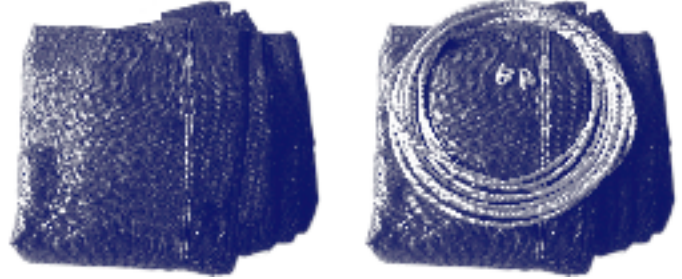

<sup>1</sup>Florida State Discount of 25%.  
 Prices for Replacement Covers are per square foot.

Additional Options

Item #	Retail & State
Logos	varies depending upon job, call for quote
Misting Systems	varies depending upon job, call for quote
Heating Systems	varies depending upon job, call for quote
Lighting Systems	varies depending upon job, call for quote



Ashton Elementary School  
 Sarasota, FL



Lackland Air Force Base  
 Misting System  
 San Antonio, TX

Surface Mount Plate

Item #	Retail	State <sup>1</sup>
SM <sup>3</sup>	\$71	\$54

<sup>1</sup>Florida State Discount of 25%.  
 Prices listed are for one (1) surface mount plate each.

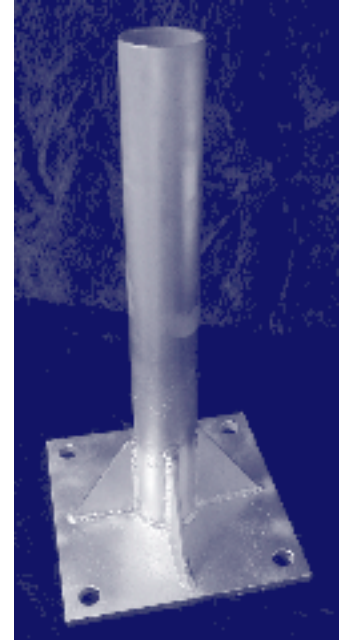

surface  
mount  
new footings

surface  
mount  
existing footings

direct  
imbedment

sleeve  
imbedment

imbedment options

## sleeve imbedment

This mounting is available for the BreezeBrella™ units only.

**Incorrect installation voids all warranties.**

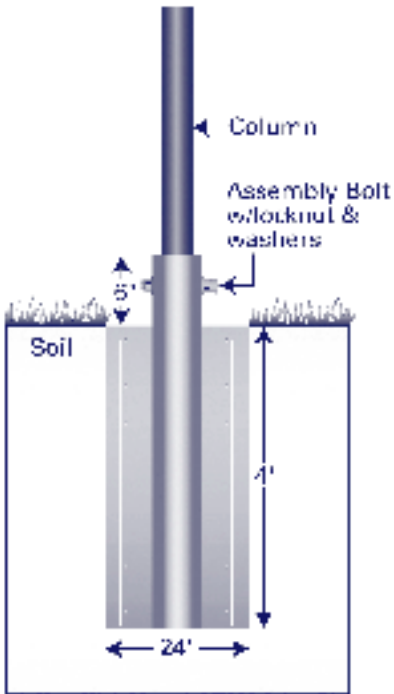

## direct imbedment

Installation requires posts to be imbedded in a concrete footing in bare soil.

Footings are specified, but are not provided.

**Incorrect installation voids all warranties.**

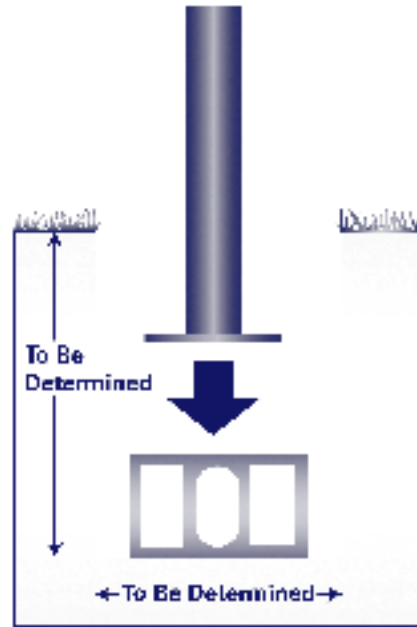

surface mount options

## new footings

Units can be surface mounted on new footings poured to specifications.

Footing requirements vary according to structure size. Please call for specifications.

**Incorrect installation voids all warranties.**

J-bolts are not supplied by Sunguard Shade Structures Corp.

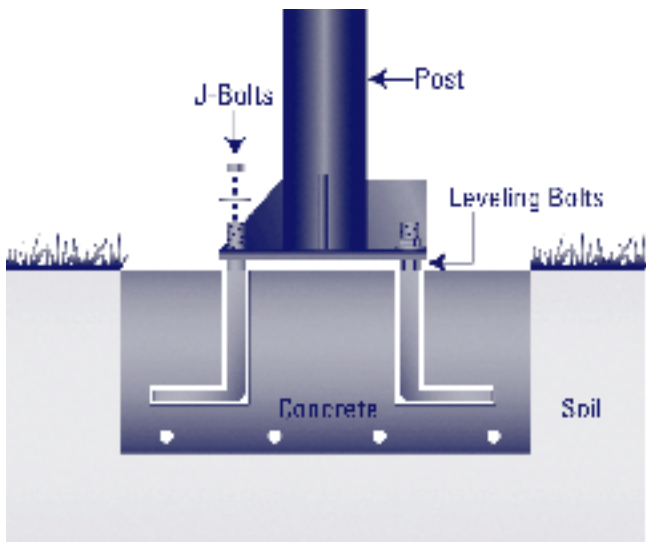

## existing

Units can be surface mounted on a 4" (minimum) existing concrete slab.

Slab requirements vary according to structure size. Please call for specifications.

(Each post must be 1' from any edge. For example, a 25'x25' pad takes a 23'x23' unit.)

**Incorrect installation voids all warranties.**

Anchor bolts are not supplied by Sunguard Shade Structures Corp.

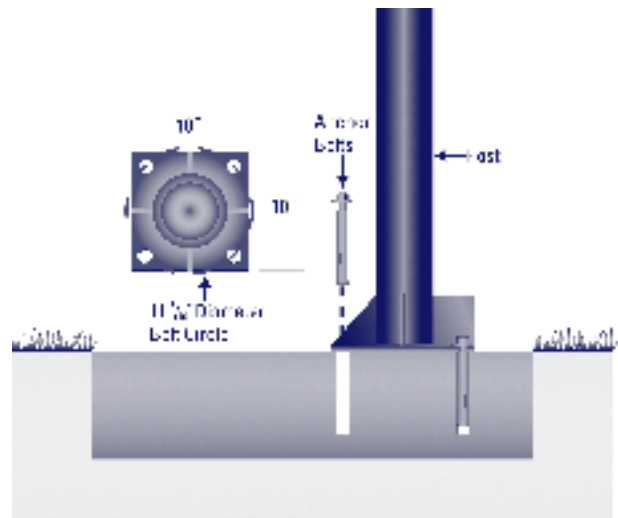





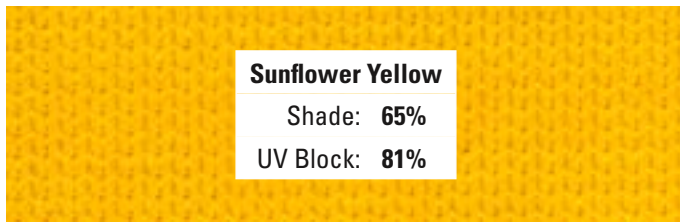
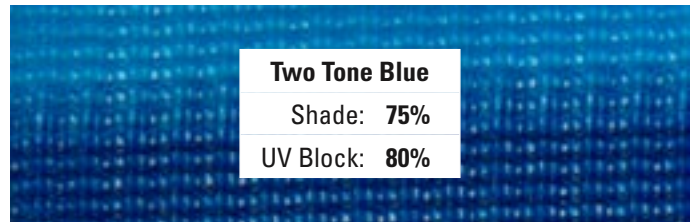
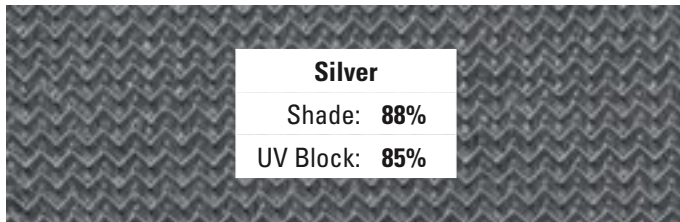
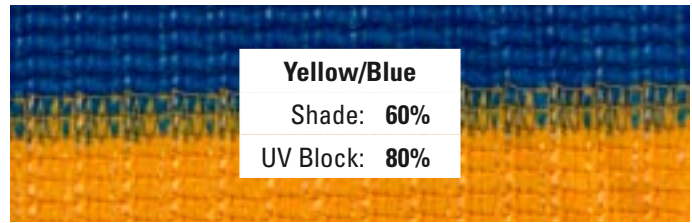
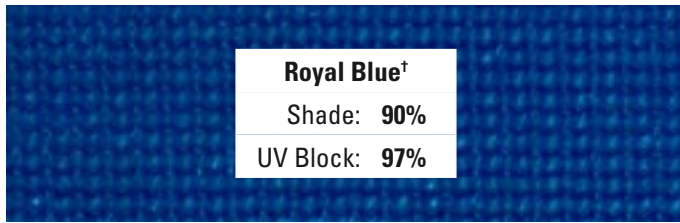
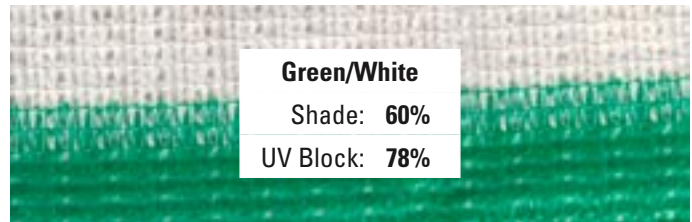
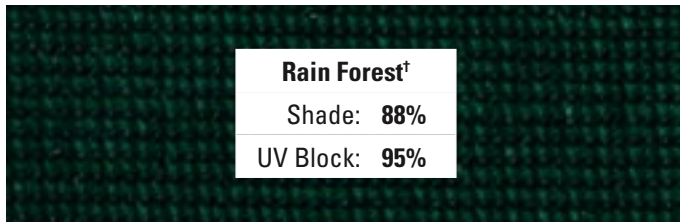
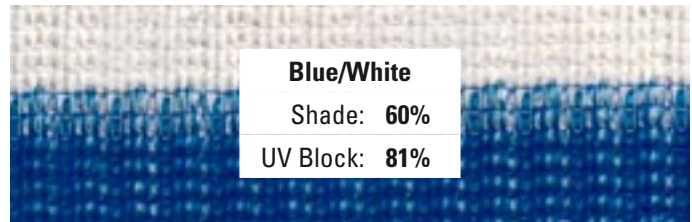
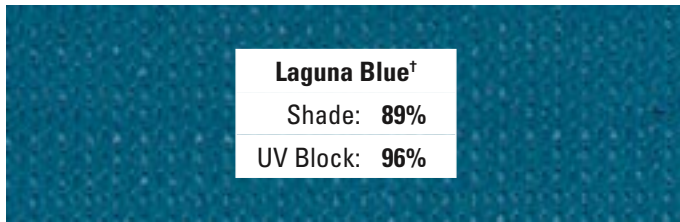
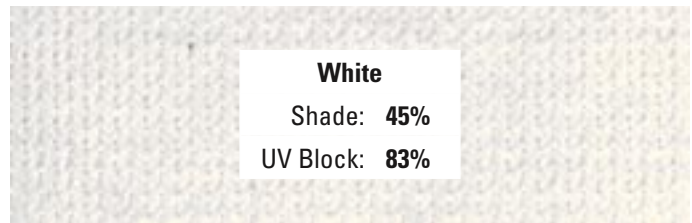
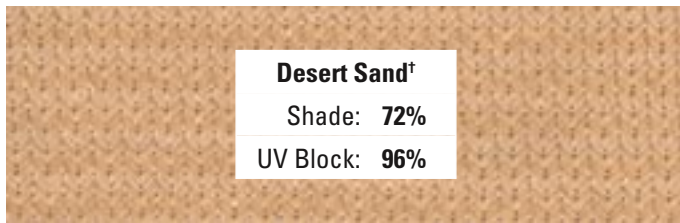
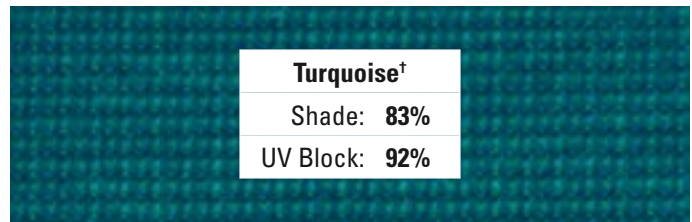
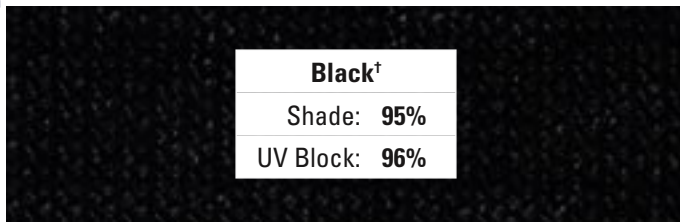
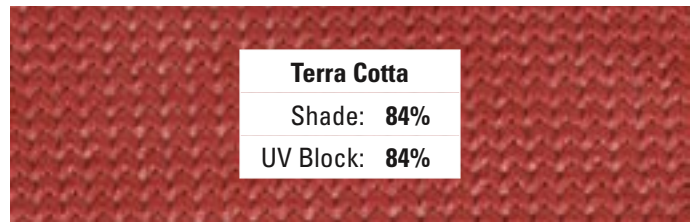
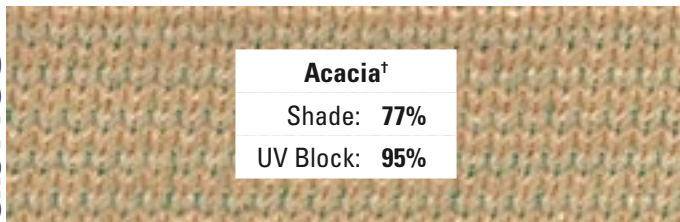

<sup>†</sup>Indicates fabrics certified by an independent laboratory to meet AMC Cancer Research Center guidelines.

Due to variations in printing techniques and monitors, colors may be different than they appear. Please contact Sunguard Shade Structures Corp. for a swatchbook.

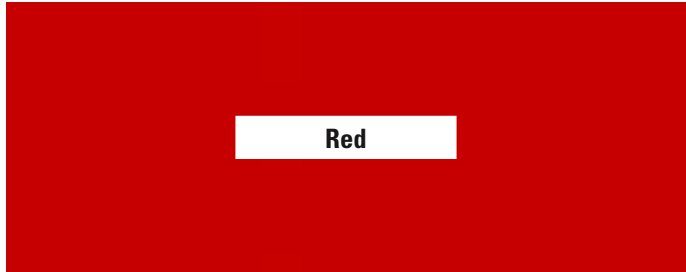
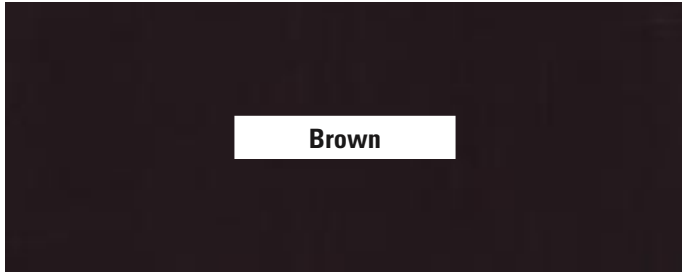
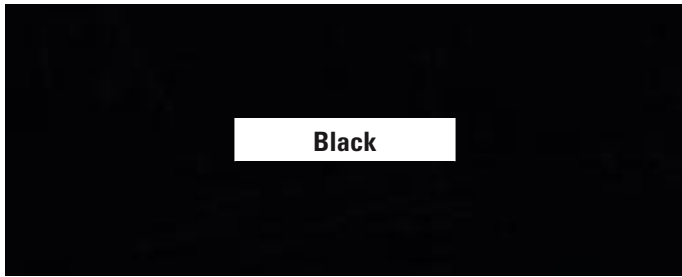

Due to variations in printing techniques, monitor calibrations, and manufacturer techniques colors may be different than they

appear. Please contact Sunguard Shade Structures Corp. for a swatchbook.





Woodmere Park  
Venice, FL



Fountain Apartments  
Venice, FL



Englewood Sports Complex  
Englewood, FL



Nokomis Park  
Nokomis, FL



St Mark's Church  
Venice, FL

Sarasota Growers  
Sarasota, FL



## Warranty

Sunguard Shade Structures' fabrics are warranted for 10 years against failure due to rot, UV deterioration, or faulty workmanship. **This warranty is non-prorated.** Steel frames are warranted for 20 years against failure due to corrosion, deterioration or faulty workmanship. This warranty does not cover vandalism, failure to provide routine maintenance, nor Acts of God. **Cover must be removed in winds expected to exceed 75 mph. Incorrect installation voids all warranties.**

## General Notes

Units are designed for perimeter posts only. All units are clear span—no center support posts necessary. Most units require only four (4) posts, however, larger units and extra tall units may require additional perimeter posts.

Sunguard has over 600 standard sizes and shapes—all professionally engineered to meet national building codes and wind load requirements ASCE 7-02 (ASD, LRFD). If you don't see the size you are looking for, please call for a quote from our data bank. Prices are subject to change.

## Packaging & Handling

Standard packaging and handling is included in the net price listed. Additional packaging is required west of the Mississippi River, add \$60 per unit.

## Powder Coat Finishes

Sunguard proudly provides a top quality, cold-rolled, flo-coat galvanized finish as standard on all units. Customers may select one of our 10 standard powder coat colors as an alternative finish. Custom colors are available, customer must provide a swatch for matching.

Custom colors.....+10% to list price

## Terms & Conditions

Prices FOB—Sarasota, Florida

**4%**—discount when full payment is received with order.

**Net 30**—from date of invoice to all government agencies and those with approved credit.

**Note**—Accounts exceeding 30 days of invoice will be billed finance charges at the rate of 1.5% of unpaid balance with a minimum \$25 charge.

**Installation & freight are not included in the prices listed.**

## Ordering

When ordering, we **must** have six (6) essential items of information:

- 1) Model Number
- 2) Fabric Color
- 3) Steel Finish
- 4) Installation (Mounting Type)
- 5) Post Height
- 6) Most Recent Site Plan or Survey with all playground equipment noted (when requesting sealed drawings)

## Attention Designers

All squares, rectangles and triangles can be connected to expand coverage or to meet architectural requirements. Units are connected by special interconnecting posts. Calculate price by using standard unit prices of the units being connected. Please specify on the purchase order that you want interconnecting units.

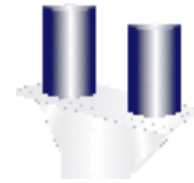

## Sealed Drawings

If a sealed drawing is required a **site plan or survey must be included with the order, electronic format preferred.** All existing structures, including playground equipment must be noted. Additional charges will be incurred for sealed drawings.

## Custom Applications

Sunguard Shade Structures' product designers and engineers can design units to meet most requirements. Send us a survey, a site plan or a proposal and we will be glad to give you a quote and preliminary design. We can custom design for snow loads and wind loads up to 170mph.

## Post Height

Additional post heights of 9'-12' are available, please call for a custom quote. Remember, the higher the posts, the smaller the shade pattern; use the lowest height consistent with obstacle clearance possible.

# *Price List*

**Effective August 01, 2005**



*[www.floridasunshade.com](http://www.floridasunshade.com)*

*[sales@sunguard.net](mailto:sales@sunguard.net)*

*1.800.319.1010*

*This price list supercedes all previous price changes.  
Information & pricing subject to change without notice.*

*Premier Manufacturer of Shade Structures* ● *Promoting Sun Safety & Cool Comfort*